

ELLIETT

HANDLEIDING - MANUAL - MANUEL - ANLEITUNG

Maestro

1. Introduction



1.1 Carefully Read this Operating Instruction Manual.

Eliet machines are designed for safe and reliable use if they are operated in accordance with the instructions given. Carefully read this operating instruction manual for using the machine. Failure to observe this may result in personal injury or damage to the equipment.

1.2 Identification Data - ELIET MAESTRO

Write the identification data relating to your machine in the boxed areas:

Engine

Power

Serial number

2. Warranty



2.1 Warranty Card

To be eligible to obtain warranty you must mail the completed warranty card within one month of the date of purchase to the address specified below.

ELIET NV

Zwevegemstraat 136

B-8553 Otegem Belgium

Phone: (+32) (0)56 77 70 88 - Fax: (+32) (0)56 77 52 13

3. Welcome



Welcome to the family of ELIET customers

We would like to thank you for the confidence that you have placed in ELIET and we are convinced that you have purchased the very best machine. The life expectancy of your ELIET machine is much dependent on the way you care for your machine. This user manual and the engine manual provided will assist you in this respect. If you follow the instructions and suggestions in these manuals, your ELIET machine will operate for a very long time in optimal condition.

Read this instruction manual carefully before operating this machine. This will prevent you from operating the device incorrectly.

For your own safety, take into account the safety instructions given in the appropriate chapter. Even when you are thoroughly familiar with operating such equipment, it is still advisable to read these pages carefully.

ELIET is constantly working on further developments for all machines and devices ; bearing this in mind, we also reserve the right to supply equipment that can differ slightly in terms of shape, technology and accessories. The descriptions and technical data in this manual are accurate as of this printing. Certain illustrations and descriptions may not be applicable to your specific machine, but instead relate to a different version of the machine. In turn, we trust that you will understand if the texts and illustrations in this manual cannot lead to any claims.

If you still have any questions after you have read this manual, we request you to contact your ELIET Dealer.

ELIET AT YOUR SERVICE

ELIET

Zwevegemastraat 136
B-8553 Otegem
Belgium

Phone: (+32) (0)56 77 70 88
Fax: (+32) (0)56 77 52 13
Email: service@eliet.be

4. Table of contents

1. Introduction	3
1.1 Carefully read this operating instruction manual.....	3
1.2 Identification data - Eliet Maestro	3
2. Warranty	3
2.1 Warranty card	3
3. Welcome	4
4. Table of contents	5
5. Operator Safety Warnings	6
5.1 For your information	6
5.2 Caution	6
5.3 Warning	6
6. Main parts	7
6.1 Machine survey	7
6.2 Engine	8
7. Safety regulations	9
7.1 Safety messages	9
7.2 Safety features	11
7.3 General safety precautions	12
8. Dealer preparation	15
9. Operating instructions	18
9.1 Preliminary checks	18
9.2 Filling up with petrol.....	19
9.3 Preparing the operating area	20
9.4 Starting the petrol engine	20
9.5 Using the machine	22
9.6 Emptying the collection bag	24
9.7 What to do about engine stalling	25
9.8 Cleaning the machine	26
10. Transporting the Machine	27
11. Maintenance	29
11.1 General	29
11.2 Servicing schedule	30
11.3 Routine checks before the start of each work session	31
11.4 Maintenance after 20 running hours	34
12. Off-Season Storage	38
13. Equipment Specifications	39
14. EC Declaration of Conformity	40

5. Operator safety warnings



Certain symbols in this manual are used for additional information and for your safety.

5.1 For your information



For your information:

This symbol is used to denote either specific information and/or actions, or where to find additional information regarding the related subject.

5.2 Caution



Caution:

This notice identifies safe usage habits. This, in order to avoid erroneous actions prone to be source of personal injury or damage to the machine.

5.3 Warning



Warning:

This notice is used to denote danger to consider in these specific circumstances. Thus remain alert, in order to ensure your own safety.

6. Main parts

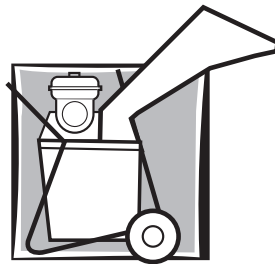

To fully grasp the contents of this operator's manual, you need to be thoroughly familiar with the terminology used for the descriptions. In this chapter you can find a set of parts identified by name.

It's a good idea to take time to study the machine beforehand for an improved understanding of the descriptions given in this user's manual.

6.1. Machine survey

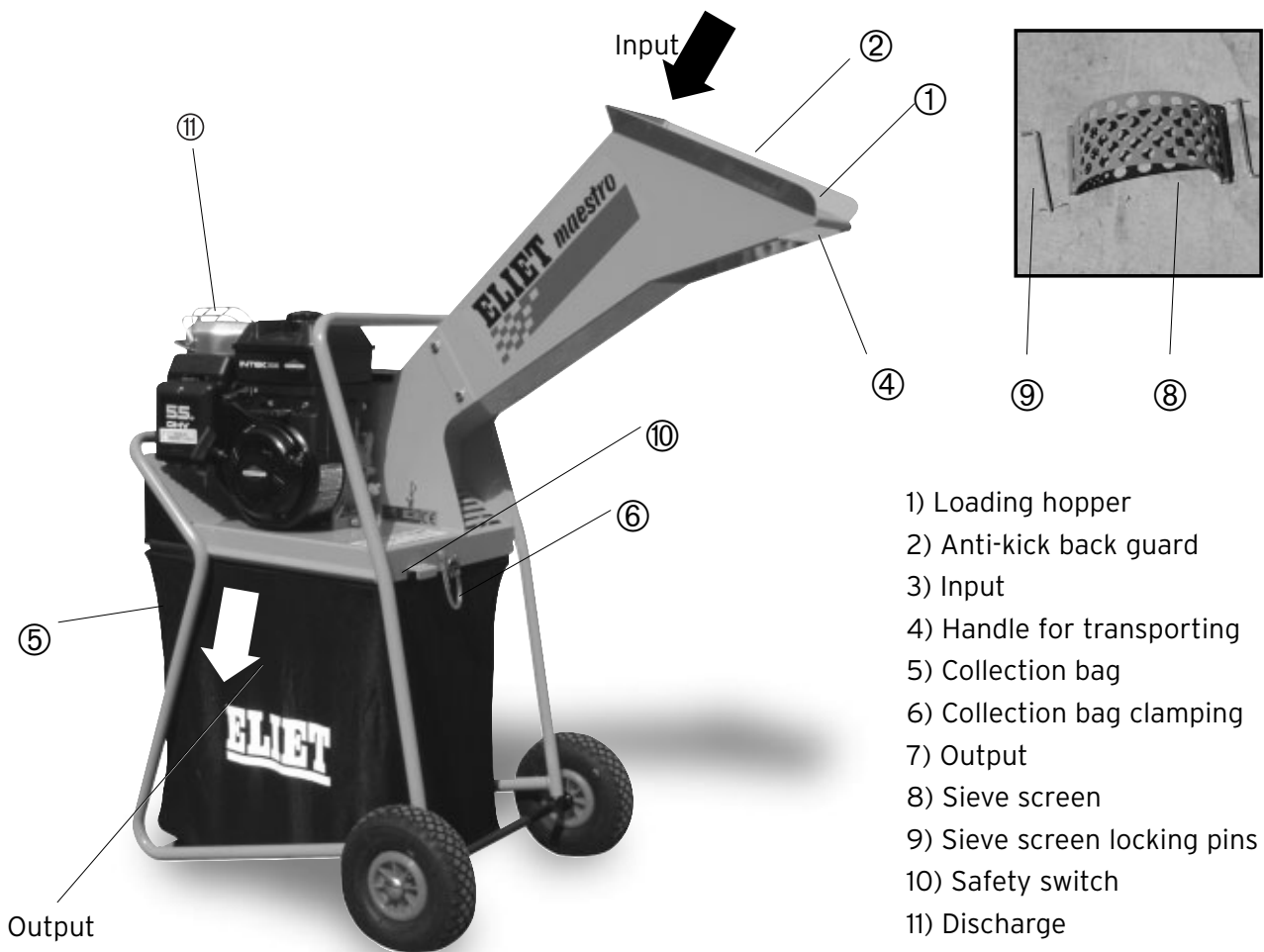

6.2 Engine

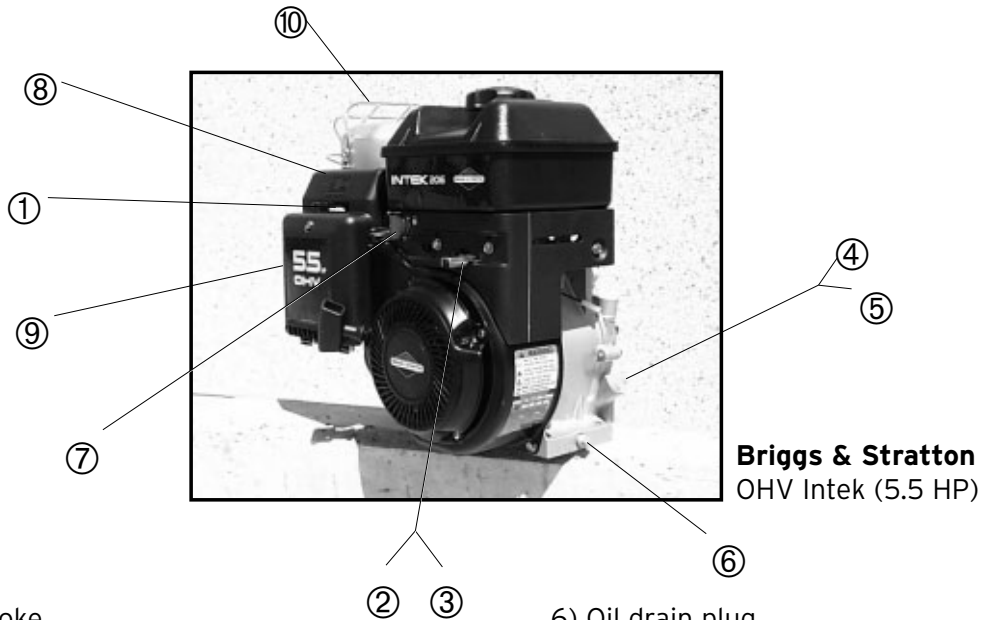

- | | |
|-------------------------|------------------------|
| 1) Choke | 6) Oil drain plug |
| 2) Engine speed control | 7) Fuel shut-off valve |
| 3) On/Off switch | 8) Spark plug |
| 4) Dipstick | 9) Air cleaner |
| 5) Oil filler cap | 10) Muffer |



For your information:

Reference in this manual to right or left hand side, back or front of the unit is observed from the machine operator facing the branch feed.



For your information:

Your ELIET Dealer is at your service, ready to provide you with maintenance or advice to keep your ELIET machine operating at peak efficiency at any one time. Parts and lubricants can be obtained from your ELIET Dealer. These service parts are manufactured to the same stringent accuracy and degree of craftsmanship as the original equipment.



Caution:

For your safety, use only genuine ELIET parts on ELIET machines.

7. Safety Regulations



7.1 Safety Messages



Decal location : Near to the collection bag handle. Warns of danger of hand injuries. Always wait until the shred knives have come to a complete stop before opening the shredding screen of the shredding chamber. It is essential to ensure that the engine is shut off prior to removing the collecting bag. (stock no. : BQ 505 010 070)



Decal location : On the flat face of the motor bed plate. This decal is used to denote all the safety precautions using icons.

1. Read this owner's manual carefully in its entirety before attempting to operate this unit.
2. Always wear the appropriate protective garment when operating the machine (protective gloves, safety goggles, hearing protectors).
3. Performing maintenance or operating the machine can be source of hand injuries. The need for safe operation practices is something that cannot be overemphasized !

(stock no. : BQ 505 010 050)



Decal location : Again, on the flat face of the motor bed plate. This sticker reminds the user to shut the engine off and to disconnect the sparking plug cap prior to carrying out any maintenance.

(stock no. : BQ 505 010 040)



Decal location : On the safety screen inside the feed hopper. This sticker warns the user of the danger of hand injuries and of flying debris. These are two risks - inherent in chipping branchy material - which are catered for by the safety screen. This sticker reminds the user how to operate the shredder in a safe way. No attempt should be made to put your hands past the safety screen !

(stock no. : BQ 505 010 140)

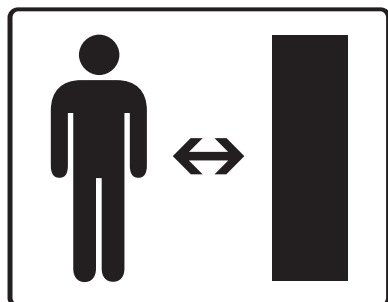

Decal location : Again, on the flat face of the motor bed plate. This sticker reminds the user to keep bystanders out of the area during machine operation.

(stock no. : BQ 505 010 150)

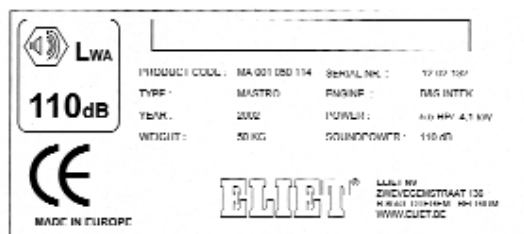

This sticker is used to indicate all the machine identification data.

- Year of manufacture
- Model
- Type number
- Serial number
- Power
- Weight
- Guaranteed A-weighted sound power level

Moreover, the sticker indicates all manufacturers' information.

The CE mark on the label testifies the conformity to European Standards.

7.2 Safety Features :



The collection bag :

The collection bag is located on the underside of the machine. Remove the collection bag and the motor automatically shuts off. In so doing, the collection bag prevents you from inserting your hands into the rotating shred knives. In order to prevent the collection bag from opening when shredding, it must be secured in position using a slide pin.



Discharge funnel :

A discharge funnel is available as an option and provides an alternative to the collection bag supplied as standard. The latter fully complies with all applicable safety legislation.



Warning :

The knives may continue to rotate for a few seconds after the engine is shut off.



Safety screen :

The steel sheet located within the infeed opening, is specially designed to protect the operating personnel against flying wood chips. Any attempt by the operator to insert his hands beyond this steel sheet is strictly forbidden.



Loading hopper :

The shape of the loading hopper ensures the safety of the operator and is a protection against his personal carelessness. If the operator ignores the warning, and inserts his hands beyond the debris deflector shield, then this hopper impedes access to the shredding chamber inasmuch as injury caused by the shredding knives through the infeed opening is virtually impossible.

Rugged construction :

The robust construction not only adds to the long operating life of the machine but also provides extra user safety whenever there is an unforeseen emergency.



Sound absorption :

The acoustic housing accommodating the knife drum gives excellent noise reduction whilst shredding, therefore, minimising noise nuisance for both the operator and the surroundings.



Safety wear :

For your safety, we strongly recommend to use the safety kit supplied as standard. It contains your Personal Protective Equipment (PPE) : that is, safety goggles, ear defenders and protective gloves.

7.3 General Safety Precautions

- The owner must retain the manual during the complete service life of the machine. It serves as a reference for the user, therefore, enabling the machine to be used and maintained in accordance with the correct instructions.
- This machine is designed solely for shredding branchy material, prunings, leaves and all kinds of organic garden debris. Any use other than the designated operation is at the risk and responsibility of the operator.
- According to the manufacturer,, this model will take branches up to 40 mm diameter. Branch feed is not mechanically limited to this stated capacity ; it follows that any attempt to introduce thicker branches must be avoided. For your own safety on no account should any attempt be made to introduce stems thicker than the stated capacity.



Warning:

Accepting branches with diameter up to 40 mm, this machine, however, is not designed for continuous shredding to the stated capacity. For your own safety we encourage you to take into account this limitation.



- Never attempt to shred branches that are frozen. The operator's position when shredding is the surrounding area within arm reach located on the front of the infeed opening. This equipment must only be operated when stationary. Here, make sure the tyres and the frame are brought into contact with the ground.

- The equipment must under no circumstances be modified.
- Never use a step for feeding the machine with material.
- Observe all safety instructions when using the ELIET machine ! Carefully read the instructions on using the machine. All these instructions relate to your personal safety.



For Your Information :

Also, read the engine manual that is also supplied with the machine. This contains the necessary information on designated use and correct maintenance of the engine.

- Read the chapter that is meant for the Dealer (see Chapter 8) to find out whether the machine has been delivered as per instructions.
- On delivery of unit, first allow the Dealer or a professional to give you some instruction.
- Read and observe all safety messages posted on the machine in the form of decals.
- It is assumed that the operator of this machine is mature enough and has enough common sense to make decisions by himself.
- All persons using the machine are assumed to be familiar with the safety instructions. The operator is fully liable for the use of the machine in regard to himself and to third parties.
- Underage persons must not operate the machine. However, this does not apply to youths above the age of 16 years, who are learning to operate the machine under the supervision of an experienced operator. Children and animals must be kept well away from the machine.
- ELIET recommend that the machine should not be lent to others. However, if this is done, only lend it to persons who are familiar with the machine. Always ensure that the user is aware of the potential hazards, and ensure that he reads the manual before using the machine.
- This machine must only be operated by persons who are in a good physical condition. If you become tired during the work, take a rest in due time. Persons consuming alcohol or drugs must not operate this machine.
- You must wear proper apparel to operate this machine. That is, clothing covering the whole body, heavy protective gloves and closed nonslip footwear.
- Do not wear loose fitting clothing (a shawl, for instance, should be avoided by all means). Long hair should be contained using a cap or a headband, or worn in a ponytail.

**Caution:**

For the protection of the most sensitive senses, ELIET recommend hearing protectors and a safety goggle. These are included with the machine.

- Never work in conditions where the light intensity is less than 500 Lux.
- During work parties, do not allow bystanders to come within the risk zone that stretches up to 5 m around the machine.
- When leaving the machine, the engine must be switched off.
- When parts must be renewed as a result of wear or failure, you must always request genuine ELIET service parts from your ELIET Dealer. This is important in the interests of your own safety.
- Use the machine in a manner respecting environmental regulations.
 - a) Avoid unnecessary machine running while not at work.
 - b) Avoid spilling petrol while refilling.
 - c) Service the engine regularly in order to achieve optimum combustion.

8. Dealer Preparation

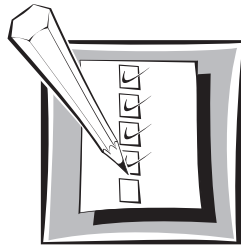

Warning:

As an ELIET Dealer you should familiarise your customers with the machine functions and also point out the possible dangers while using it. You are expected to carefully go over the maintenance points of the machine together with the new owner. You are supposed to repeat these instructions until the new owner has fully understood everything.



The manufacturer, ELIET, wish to re-emphasise that the Dealer must expressly point out to the customers that they must examine the bolts which retain the shredding knives for security of fixings after the first 5 (five) operating hours.

When the machine has been removed from its packaging, it is still not completely assembled. Your ELIET Dealer is expected to complete these preparation steps. Following are a few guidelines.

Following parts are found in the packaging on unpacking.



- Machine
- Loading hopper
- Two tyres
- Wheel holder
- Collection bag
- Fasteners kit
(containing two Starlock fasteners)
- Personal Safety Equipment kit
- Owner's Guide



- First thing you have to do is fit the tyres to the wheel holder. Secure them in position using the Starlock fasteners found in the plastic bag. Apply some grease (Sunoco Multipurpose LR-EP2, for instance) to the shafts beforehand.



- Next, slide the wheel holder into the machine chassis. Push the wheel holder in even increments until the frame tubes are a sliding fit over the vertical tube ends of the wheel holder.



- After you have fitted the wheels to the chassis, proceed with installing the loading hopper. The 4 bolts (M8 x 20) and the spring lock washers (M8) are factory fitted.



- Fix the collection bag to the frame that fits into the machine. In order to do so, the collection bag top face accommodates plastic retaining clips.

- The machine is packed without oil or petrol. The Dealer is expected to replenish with the correct oil and petrol as per instructions contained within this manual (or those within the engine manuals).
- With petrol engines, engine speed is factory set at 3,200 rpm.



Caution:

In the event of a petrol engine, the Dealer will pay particular attention to setting the correct engine speed. If the number of revolutions is too high, this will cause additional vibration with the resultant increase in wear rate. If the number of revolutions is too low, the machine will sacrifice power.

- The Dealer performs a test run on the machine and confirms that everything is functioning properly (such as the safety contact at the collection bag).
- Lastly, the Dealer makes sure the warranty card is filled in completely and signed. This, in order to avoid any warranty disputes. In this respect, read the warranty conditions.

9. Operating instructions

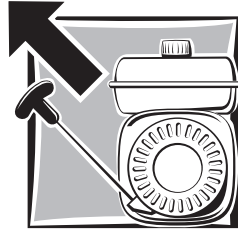

9.1 Preliminary checks



Caution:

Before commencing the work, it is recommended to get into the habit of checking the following points.

Checklist

1. Check the oil level of the machine. To this effect, remove the dipstick and make sure the oil level has not fallen to danger level (in necessary cases, see Chapter 11.4.2).
2. Check ample petrol in tank beforehand. If not, add fuel (see Chapter 9.2).
3. Make sure that the orifices of the air cleaner are not clogged (if necessary, see Chapter 11.4.3).
4. Satisfy yourself that the shredding knives are firmly in place and in good condition. If they need to be sharpened, this must be done first. Check the knives for cracks and nicks and replace immediately as needed (see Chapter 11.5.6).
5. Check whether the screen at the rear of the machine is secure, and has been fastened in the correct manner.
6. Verify that all of the machine's safety items are operating correctly (see Chapter 7.2).

Once these items have been checked and approved, you can prepare the area of operation (see Chapter 9.3) and move the machine to the work site.

9.2 Filling up with Petrol

Top up if the machine runs short of petrol. Use only clean, fresh gasoline. Use lead free fuel, gasoline with a minimum of 98 or 99 octane is to be preferred.



Warning:

Under certain conditions, gasoline is extremely flammable and extremely explosive. Fire and explosion caused by gasoline can result in serious burns or damage to property.

Thus, always take note of the following points.

- Never fill tank when engine is running.
- Topping up with gasoline may never occur while an engine is running. Always allow a few minutes for the engine to cool off before topping up with fuel. Use only fresh gasoline. In order to reduce air pollutant emissions, ELIET recommend lead-free gasoline. In order to extend storage life, mix additives with the fuel.
- Store fuel only in an approved container. Keep this container out of reach of children.
- Never top up gasoline at a location where work will be performed later. Always keep the area of operation clear of all persons (10 m minimum). This is to prevent any fire risk.
- Clean the fuel fill area first and then remove this cap. Never fill a tank to over 85% of the tank's capacity. Top up allowing approximately 10 mm of tank space. Thus, do not fill the tank completely to the opening in the tank.
- Always use a funnel or spout to pour the petrol into the tank. Suitable funnels can be obtained from your ELIET Dealer.
- Refit the cap onto the tank. If petrol is spilt during the filling, the engine must be immediately cleaned.
- Be careful not to spill petrol onto clothing. Should clothing become contaminated be careful to change clothes as soon as possible.
- It is unsafe and therefore expressly forbidden from filling the fuel tank in the vicinity of smokers or a naked flame.
- If fuel comes into contact with the eyes or is taken internally, get prompt medical attention.

9.3 Preparing the Operating Area

- Clear the area first where the machine is to be used. In addition, the paths along which the plant trimmings are removed, must be kept clear, thus releasing the operator from the worries of tripping up over them. The operator must also ensure that his safety is not compromised.
- On slopes, never operate the machine (no forward or lateral slope).
- Sort out as much as you can before you start the machine up. In this way, you are pretty sure that no foreign objects will enter the machine with the material to be shredded.
- With foreign objects are meant : any non-organic object or branchy material in excess of the stated capacity (such as metal, stone, plastic, pvc, cords,...). Some of these can cause serious damage to your machine or can be ejected, virtually as projectiles towards the user.
- Always position the machine so that the wind will blow the dust produced away from the engine.
- Also, check which way the wind is blowing to make sure the exhaust fumes will be blown away from the operator's position.

9.4 Starting the Petrol Engine



Caution:

Never start never the machine if dust or dirt lies on the engine between the cooling fins or is present on the engine. This prevents optimal cooling of the engine and more importantly can cause fire.



- You will be unable to start the engine as long as the collection bag or the optional discharge funnel hasn't been pushed fully in the chassis and locked in position.



Four your information:

Also, read the engine manual.

In the chapter entitled General (section 6) you can find more information on the key engine functions.

- Prior to running the engine, first check whether adequate oil and fuel is present in the engine, if you didn't already. If considered necessary, read the following chapters.

§ 11.3.2 Checking the oil level in the engine crankcase

§ 9.2 Filling up with petrol

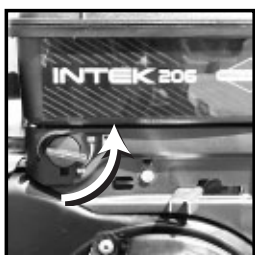

Fuel shut-off valve



Choke



Throttle control lever

- It is essential to ensure that the loading hopper is free of any material.
- Open the fuel shut-off valve by turning it in the ON position. Foto
- Adjust the throttle control lever fully to the right to full speed. Foto
- Move the throttle control lever to the CHOKE position, therefore, closing the choke.



Warning:

Before starting up the machine, make sure to wear ear defenders.

- Start the engine by giving the recoil starter cord a strong pull.
- After the engine is running, quickly move the choke lever to RUN. This ensures that the engine does not receive too much petrol. If you forget to do this, then the engine will slow down and start to smoke profusely. Eventually, it will stop. Restart the engine without choke.
- When engine starting is problematic, it signifies that the spark plug is fouled. It follows that the spark plug needs cleaning or replacing (see Chapter 11.5.2).



Warning:

The knife drum is driven directly by the engine. The knives remain engaged. This means that the machine becomes dangerous as soon as the engine starts running. Therefore the engine must be switched off immediately whenever you encounter a situation in which you lose control.

How to Quickly Turn off the Machine ?

- Through moving the engine throttle control lever to the left (see engine manual).
- Sliding the unlocked collection bag backward will also cause the engine to shut off.

9.5 Using the Machine

9.5.1 Before Starting Work :

- Wear proper apparel, protective gloves and safety equipment as instructed in this manual (see Chapter 7.3).
- A good gardener is well organised and plans his work. This will enable him to have an overview of the work and to avoid accidents and incorrect actions with the machine.
- The wood is systematically stacked before commencing the work : thick branches, thin branches, leaves and damp material. Ensure that the material does not contain any foreign objects.
- The engine must only be started once arrived at the work site.
- Never run the machine in an enclosed area. If this is done, there is a danger of being poisoned by the fumes from the engine.
- Always adjust throttle to full speed (throttle control lever to the right).
- After the motor has started, allow it to warm up. This ensures that the motor attains its full power. The importance of this cannot be overstressed when shredding branchy material of maximum branch size.



Caution:

Once the engine is running, the shredding knives are rotating, therefore, irrevocably shredding anything that is introduced into the loading hopper.

9.5.2 During the work :

- You must be careful when performing work. As long as you're operating the machine, focus your concentration completely on the work.
- When inserting the material, always hold it firmly. The rotational direction of the knife drum makes for steady material feed into the hopper. If you stop holding the wood firmly, it will automatically be pulled much too quickly into the machine which will inevitably lead to the machine stalling.
- You yourself will thus control the speed at which the wood is fed in (faster or slower). The speed at which the wood is fed in will vary according to branch size.
- You will listen attentively to the characteristics of the motor when feeding in the wood. If you notice a significant drop into engine speed, immediately pull the wood back out in order to allow the engine to speed up again.



Caution:

When feeding in wood, never insert your hands beyond the steel shield.

By raising the safety screen, you are no longer protected against wood chips flying out of the machine.



■ If the equipment is primarily used for shredding leaves or damp material using the standard sieve screen, the chances are good that orifices will clog. To alleviate this problem, The ELIET damp material shredding screen is a way around this. This shredding screen is available from your ELEIT Dealer.

■ If only a small volume of leaves is to be processed, they can be easily shredded using the standard screen. However, in this case, ELIET recommend that leaves and branches should be shredded alternately. In so doing, the wood chips prevent the screen orifices from clogging.

■ As the waste chippings are collected in a collection bag, care must be taken in making sure at regular intervals that the chips will not block the discharge situated on the underside of the machine. Collection bag filling can be checked by looking through the grid found beneath the loading hopper.

■ To promote collection bag consolidation, shake the bag regularly to distribute the waste chippings to fill the empty spaces in the collection bag.

■ If you should notice that, despite all of the preparation, a foreign object still finds its way into the machine, the engine must be immediately shut off. The foreign object must be removed first and then the machine must be examined for damage. If damaged, have the damage repaired promptly.

■ As a rule, the engine will shut off automatically on removing the collection bag. If not, possibly as the result of an electrical defect, immediately turn the engine off yourself and refrain from using it until repaired.

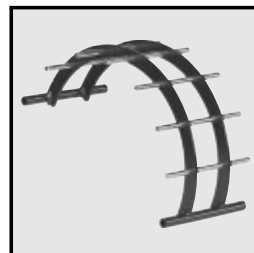

REMOVING THE COLLECTION BAG = MOTOR SHUT OFF

9.6 Emptying the collection bag



- The bag needs emptying when the waste chippings in the collection bag has reached the bottom of the discharge chute of the machine.
- In order to do so, always first make sure to shut off the engine (failure to do so will cause the engine to cut out automatically on collection bag removal).
- Failure to empty the bag in time will cause the shredding chamber to get clogged up and finally come to a stop (see Chapter 9.7).



Caution:

A machine that does clog up is a sure source of overheating with the resultant increase in fire hazard.

- The collection bag has an approximative 125 litre capacity.



Warning :

Once full, the collection bag can be pretty heavy. Which means - make sure to hold the collection bag close in towards your body as close as possible first and then lift using your leg muscles. (Lift keeping back straight and bend legs at the knees.)

Know your own capability. The mere fact of lifting things beyond your personal capacity a mere few centimetres does serious damage. Seek assistance when lifting things that are too heavy for you.



- Either you can empty the contents of the collection bag in to a wheel barrow, or you can carry the full bag to the dumping area using the wheel barrow.
- What's more, the machine can be used for transporting the collection bag once full. When doing so we suggest you use the optional carrying rack. This prevents the collection bag from trailing on the ground and comes in useful as an extra collection bag load support.
- When refitting the collecting bag you can secure it in position using locating pins.
- Alternatively, you can replace the collection bag with a discharge funnel. Again, move the machine in time as to prevent the pile of chips from blocking the discharge opening.



9.7 What To Do about Engine Stalling

Engine stalling can be traced to overloading, overfeeding, discharge blockage or lack of fuel. The engine may well not restart immediately. To remedy the problem, do the following.



1. Check ample petrol in tank (Chapter 9.2).
2. Remove all branches from the feeding aperture.
3. Pull the starter rope briefly. This allows you to find out whether the knife drum is still jammed. As soon as you feel resistance, and cannot pull the starter rope any further, stop pulling. There is no point in pulling hard on the starter rope, as this can only cause it to break or overload the starter mechanism.



4. When the knife drum got jammed, the shredding chamber needs clearing. Commence removing the collection bag from the machine in order to get access to the shredding screen through the discharge. The screen is secured by two slide pins. Free the hairpin clip from the topmost slide pin, thus allowing you to remove these pins. At that point, the screen is released on one side allowing it to hinge downwards.



Warning:

The knives are razor sharp, avoid cuts to the hands. Wear gloves !

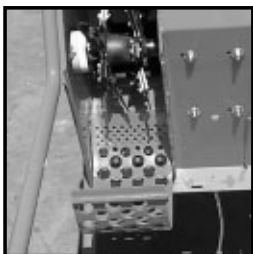

5. Remove all wood chips and traces of wood that are in the shredding chamber. Carefully refit the shredding screen and check for correct refitting.
6. Refit the collection bag and restart the shredder (follow the start procedure as outlined in Chapter 9.4).
7. Perform the work more carefully in the future in order to avoid jamming of the machine.

If you notice a strange noise during shredding, immediately stop the work. Stop the engine and investigate the cause of the defect. Before proceeding, perform the necessary repairs.

9.8 Cleaning the Machine



If the machine is not cleaned, this will lead to increased wear. If the machine does not operate optimally, this can compromise the safety of the user.

Disadvantages associated with non-cleaning

1. Increased wear on bearings
2. Increase in sealing wear rate
3. Reduced cooling efficiency
4. Fire hazard
5. Inability to detect fractures or cracks
6. Damage to paint coating
7. Stickers becoming illegible.

■ Each time after the machine is used, make it a habit to spend some time cleaning the machine. The cleaning of the machine can also be considered to be a visual check. This lets you detect cracks, breaks or lack of lubrication in time.

■ Special attention must be paid to the following items.

■ The engine must remain free of dust and dirt. In particular, the cooling fins must be clean and the area around the exhaust pipe must be unobstructed. The area around the filler plug must also be kept clean so that dirt does not enter the fuel tank.

■ The bearing bushes must be free of sand and dirt that sticks in the lubricant. After wiping down, reapply lubricant (see the list of lubricants in Chapter 11.3).

■ Using a dry cloth, remove any dirt from the chassis. Pay special attention to places where stickers with safety messages are displayed.

■ Decals used to indicate safety messages, that are no longer legible must be immediately replaced. Obtain these original decals from your ELIET Dealer.



Caution:

Wear proper apparel when cleaning.

Gloves are required.

■ When cleaning, use a dry cloth, soft brush, etc. To remove grease, use penetrating oil containing molybdenum disulphide. This spray lubricates and also dissolves rust. (Do not use any cleaning products that affect paint or stickers.)

■ Steam cleaning of the machine is permitted. However, never point the water jet for long periods in the direction of bearings, electric contacts or filler caps. Water is known to be the main cause of corrosion and must, therefore, be avoided at all times. Allow the engine to cool down prior to cleaning it down with a cold water spray.

10. Transporting the machine



- Make sure to clear the shredding chamber before moving the machine. Make sure the infeed opening is free of branchy material.
- When moving the machine over greater distances (over 2 m), always take care to turn off the engine.
- The working position must be when the machine is stationary. It follows that in order to move the machine status must be changed from stationary to mobile. In order to do so, pull the machine towards you grasping the loading hopper handle, whilst tipping it forward round the wheels. Putting your foot against the wheel axle comes in useful when tipping the machine forward.
- Continue to tilt the machine until the loading hopper handle is at no more than 80 cm from the ground.



- Then, grasp the chassis upper tube with your left hand while holding the loading hopper handle with your right hand. In so doing, you can hold the machine with a firm grip for smooth pulling and pushing.
- Only adults may move or transport the machine.
- Also, during the transport, do not allow children, unauthorised persons or animals within a radius of 3 m around the machine.



- It is critical to judiciously select the route in such a way as to release yourself from the worries of tripping up over some obstacles. The transport route is preferably flat with an even bottom.
- When taking a collection bag full of waste chippings to the dumping area using your brush chipper, it's good practice to fit the carrying rack.
- This carrying rack assists in supporting the load of the full collection bag, which in turn adds to give long bag life expectancy.



- Use slip resistant ramps to load the machine into a van or a trailer. Ensure that these are well secured to the vehicle or trailer.
- Under no circumstances must the angle of the ramp be greater than 25°.
- Be careful and composed when loading and unloading the shredder so that the machine does not tip over and give rise to an accident.
- In the event that the machine does tip over, right it again as soon as possible. This prevents oil from leaking out of the crankcase on to the air cleaner. Try to prevent the motor from falling over, since these filters are expensive.

- When walking up a slope push the chipper out in front of you with you facing uphill.

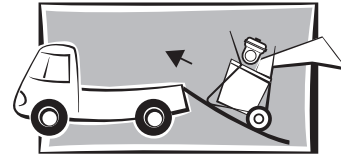

- When walking down a slope, move down backwards with you facing the machine.

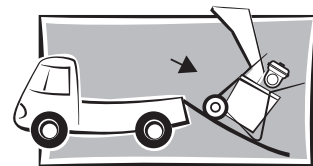

- The machine must be properly tied down within the vehicle during transport. Use sturdy parts of the vehicle's chassis to attach ropes.
- Do not overload the vehicle. Refer to Chapter 13 (specifications sheet) to find out the exact weight of the shredder.
- The maximum allowable lateral slope angle amounts to 10°.

11. Maintenance



11.1 General



For your information:

The dealer's personnel are always at your service. ELIET Dealers can always rely on comprehensive support from ELIET mfg.cy, so that they can work together to find a solution for any problem that you may have. For a repair or for the maintenance of the engine you can always contact your ELIET Dealer or an engine manufacturer authorized service center. If you need to contact these services, the model and serial numbers must always be specified of both the machine and the engine, and also describe the problem in detail.



Caution:

Only use genuine ELIET replacement parts. These service parts are manufactured to the same strict quality control and degree of craftsmanship as the original equipment.

- For your own safety, only genuine service parts must be installed on the ELIET machines.

Perform maintenance in a room intended for this purpose. This area must have the following features.

- spacious
- dust-free
- easy access
- clean and tidy
- well lit
- Quiet

These characteristics are important to enable maintenance to be performed in an optimal manner.















Caution:

Maintenance performed in an incorrect manner can subsequently compromise the safety of the operator.

- Always make sure the engine is shut off when doing service operation. For safety reasons, disconnect the spark plug cap from the spark plug or disconnect the plug (as appropriate).
- When performing maintenance, always wear gloves, and also safety glasses for some operations. These are included with the machine.

TIP: The maintenance work described can basically be performed by any person who possesses the requisite technical knowledge. However, ELIET recommend that the machine should be handed in to an ELIET Dealer for a major overhaul each year. Your ELIET Dealer will be happy to supply any service or advice. He stocks genuine ELIET service parts and lubricants. His personnel can always obtain advice and service from ELIET, so that they can provide you with an impeccable after-sales service.

11.2 Servicing Schedule

Major overhaul after 20 running hours			
Routine check before each time machine is used.			
Procedure			
	Visual check of the condition of the machine	§ 11.3.1	
	Checking the oil level of the engine	§ 11.3.2	
	Cleaning the air filter	§ 11.3.3	
	Sharpening the shred knives	§ 11.3.4	
	Cleaning the machine (and at the end of each work session)	§ 9.7.1	§ 9.7.1
	Changing the engine oil		§ 11.4.1
	Checking or changing the spark plug		§ 11.4.2
	Changing the air filter		§ 11.4.3
	General lubrication		§ 11.4.4
	Reversing and renewing the shredding knives		§ 11.4.6

Lubricants

Engine (0,75 l)

SUNOCO SUPER DENALUBE

SAE 20 W 50 API SF / CC

Bearings

NOVATIO PTFE OIL

Wheel axles

SUNOCO GREASE MULTI-PURPOSE LR - EP2

11.3 Routine Checks before the Start of Each Work Session



11.3.1 Visual Check

Check that no parts are deformed, no welded seams are cracked, and that no parts exhibit excess play. First conduct the necessary repairs if any problems are found. Check whether the machine is running at the manufacturer's engine speed (3,200 rpm) (a tachometer can be obtained from your ELIET Dealer). Never try to change the standard settings of the engine.



11.3.2 Checking the Oil Level of the Engine

- Park the machine on a level surface making sure the motor bed plate is as close to level as possible.
- Open the manual at Chapter 6 to locate the oil drain plug and the crankcase filler point.
- Take a clean cloth and clean the fill area.
- Unscrew the yellow oil filler plug, located to the right of the engine.
- This will enable you to check for correct oil level. Normally, the oil level should reach the edge of the filler point.
- If the oil does not reach the edge there is not enough oil.
- If the oil level is too low, it is simply a matter of replenishing through this filler point. Fill until the desired level is reached.
- Use a funnel with a built-in sieve.
- Only use the recommended oil.
- Immediately clean off any spilled fuel.

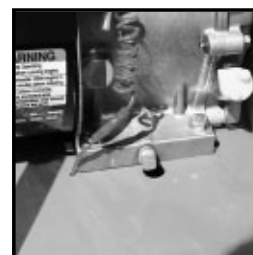
**Caution:**

Make sure that no dirt enters the casing via the fill stud.



11.3.3 Cleaning the Air Filter

- The air cleaner is located behind the black safety guard underneath the choke lever on the engine.

- This black safety guard is held by one easy to remove bolt using a screw driver.
- The filter incorporates two elements. First, there is the pre-cleaner, which consists of a metal gauze backed by a foam layer ; second there is the air cleaner proper : a multilayered conventional paper element as with cars.
- The pre-cleaner can easily be cleaned by rinsing it with some petrol and blowing through with compressed air.
- The paper filter type can only be cleaned by dusting it off or by blowing it out with compressed air.
- After cleaning, refit using a reverse sequence to that given for removal.



Caution:

If the machine accidentally falls over, check air cleaner integrity as soon as possible. If this happens, oil from the crankcase can flow via the carburettor onto the air filter. Oil on the paper element is restrictive to air flow. Dirty air filters need replacing.



11.3.4 Sharpening the Shredding Knives



Caution:

In order to avoid any personal injury, it is imperative that intervention on the machine is performed only when the sparking plug cap is disconnected.

Sharp shred knives will give the machine optimum performance and provide maximum operating speed. Enhance your own work comfort by taking some time to check the knives, and if necessary, sharpen them.

SHARP KNIVES = MAXIMUM OUTPUT



For your information:

The knives need not removing in order to sharpen them.

- Remove the collection bag from the machine.
- Raise the rear of the machine to rest on the wheels and the loading hopper (see figure).



Warning:

When tipping the machine, petrol may leak out of the fuel tank through the fill stud. Drain the fuel tank beforehand with the aid of a siphoning kit. Flying sparks when grinding can be source of fire hazard when they come into contact with petrol.

- Remove the shredding screen from below the machine for easy access to the shred knives. To do this, remove the two slide pins.
- Sharpen the blade edge of the knives using an angle grinder,



Warning:

Always wear safety glasses and hearing protection when grinding knives. Gloves, too, are obligatory during maintenance work.

- Dress along the bevel blade edge of the knife. Ensure that the blade edge is kept at the same angle.
- The top of the knife is subjected to the heaviest loads under shredding. Sharpen this as little as possible so that it is not weakened. Correct and timely sharpening of the shredding knives will extend their operating life.



For your information:

As soon as the top of the blade edge becomes blunt, the cutting edge has reached the end of its operating life and must be renewed or turned around.

- After sharpening a knife, refit using a reversal of the procedure given for removal. To permit easier assembly of the screen, apply some grease to the slide pins.

11.4 Maintenance after 20 Running Hours



11.4.1 Changing the Engine Oil

- Ensure that the engine is parked on a level surface and shut off.
- Locate the bolt that is screwed into the crankcase and which is located at the right side of the engine, at the bottom of the motor bed plate. (See the engine manual.)
- Position a 1 litre receptacle beneath the sump first and then remove the oil drain plug.
- Allow the oil (± 0.75 l) to drain into the receptacle. The bedplate has a factory hole which makes for easy draining of the oil from the underside of the motor bed plate.
- Refit and tighten the sump plug. Always clean fluid spills using a clean cloth.
- Refill the engine with fresh four-stroke oil. ELIET recommend a high quality detergent oil. SUNOCO DENALUBE SAE 20W50 API SF / CC.
- Pour ± 0,75 l of oil into the oil filler plug until it reaches the edge of the filler point.
- After filling, clean up any oil that may have been spilled.



Warning:

Too little oil in the engine leads to irrevocable serious damage to the engine.



11.4.2 Checking or Changing the Spark Plug

With B&S Intek 5.5hp engines,
ELIET recommend the following spark plug.

CHAMPION

QC 12 YC

0,8 mm

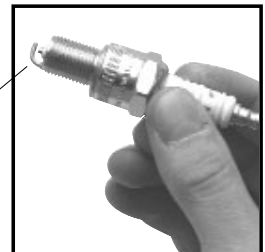

- Turn the engine off and let it cool for a while.
- For easy access to the spark plug, remove the air cleaner cover. Disconnect the sparking plug cap from the spark plug.
- Clean the area around the spark plug and remove the spark plug from the cylinder head.
- Check with the use of feeler gauges whether the gap between the plug electrodes is 0.8 mm.
- If the spark plug is fouled, replace it.

To check the condition of the ignition, perform the following.

1. Refit the spark plug cap onto the spark plug.
2. Hold the insulator part of the spark plug cap and press the outer electrode against the frame of the engine.
3. Pull the starter rope.
4. Look for sparks between the electrodes.
5. If the sparks are bright and located exactly between the centres of the electrodes, then the spark plug is still OK.
6. If the sparks are weak, irregular and not located exactly between the centres of the electrodes, then the spark plug must be renewed.



Caution:

Refitting an used or a new spark plug must be effected with great care to ensure that the cylinder head thread is not damaged.

- Torque the spark plug to 20 Nm.



11.4.3 Changing the Air Filter

This is identical to cleaning the air cleaner (see Chapter 11.3.3).

New air cleaners of the correct type are available from your ELIET Dealer or from an authorized Briggs & Stratton or Honda service centre.



11.4.4 General Lubrication

- ELIET consider it important to use high quality materials because this extends the operating life of the machines under sometimes extremely arduous conditions. Therefore we have chosen use special lubricants at the manufacturing stage. ELIET also recommend that the knife drum bearing is lubricated on a regular basis.



Caution:

Before lubricating the machine, again, satisfy yourself that it is shut off. Make sure the spark plug cap is disconnected, or the plug is disconnected from the wall socket (as appropriate).

Gloves are mandatory since the knives are razor-sharp and can cause deep cuts.



- Tip the machine forward to rest on the loading hopper.
- Remove the sieve screen from the machine to clear the knife drum bearing.
- Spray a little NOVATIO KLEENSPRAY-S on the nylon bearing bush situated on the right side and on the crankshaft bearing. Leave the cleaning degreaser for a few seconds.
- Using a cloth, remove all dirt that is lodged around the joints of

these bearings.

- Clean any spray traces and wait at least 10 minutes to allow the spray to evaporate.
- Next, apply a high quality lubricant. To this effect, be over generous in the application of NOVATIO PTFE OIL in the joints of the bearing seals and of the bearing bush.

All these greases are available from your ELIET Dealer.



11.4.5 Reversing and Renewing the Shredding Knives



Warning:

Wear protective gloves as the knives are razor sharp !

- Knives sharpened at regular intervals ensure a knife life in excess of 50 hours for each blade edge.
- When one blade edge has reached the end of its service life, simply reverse the knife, thereby enabling the machine to operate for another 50 hours. If both blade edges are worn, renew the knife as a set.
- To reverse a shredding knife, proceed as follows.
- For safety's sake, disconnect the spark plug wire.
- As with knife sharpening, tip the machine forward to rest on the loading hopper. Be careful to ensure that petrol will not leak out of the reservoir.
- Remove the shredding screen. In order to do so, remove both slide pins. This ensures easy access to the shredding chamber.



For your information:

Remove and refit one knife at a time. This ensures that reversal is performed in an orderly manner.

- To remove a knife, simply loosen and remove the three M6 bolts retaining each knife. In this situation always use two ring spanners fitted with long steels.

- Replace immediately any damaged bolts.
- Free the shred knives using a self-grip wrench.

- Remove a knife from the left-hand side, rotate it through 180° and fit it in the same position, but to the right-hand disc. Rotate the knife previously removed from the right-hand disc and fit it in the location thus freed already from the left-hand disc. Repeat this procedure for each knife of zone A.

- After you have reversed all of the knives, check every knife disc element facing the wall, to make sure the bevel blade edges of the respective knives do face the mid-point of the shredding chamber rather than the wall sheet. If this is not the case, then this means that two knives have not turned around in the correct manner.

- New sets of knives are available from your ELIET Dealer under the following part number : BU 401 100 102

- Renewing knives simply involves removing the used one and have it replaced with a new item.

- Before fitting the new knife in between the two knife discs, first remove any dirt that may have built up between both mating discs. To do so, use a stripping knife.

- Also when fitting the new knife, take care to ensure that the bevel of the blade edge - in the event of the blade holder that bends towards the wall - is facing the center of the shredding chamber.

- On renewing shredding knives, always fit new bolts and nuts.

- When refitting the shredding knives check that all bolts are tight. It is a good practice to check the bolts for correct tightness before fitting the shredding screen.

- When refitting the bolts in the discs, first make sure the nut is located on the left side of the disc. This ensures knife drum direction of rotation locks the nuts.

- The next time you start shredding, consideration should be given that new shred knives take time to stabilise. This means the knives will vibrate loose between the discs.

Thus, after the machine has been operating for (5) five hours, retighten the knife bolts.

12. Off-Season Storage



- Clean the machine (see Chapter 9.8).
- When storing the machine for long periods, it is recommended to perform the following steps.
- Conduct a major overhaul (see Chapter 11.4).
- Check all nuts and bolts for correct tightness. Checking most bolts for correct tightness simply involves the use of two sets of open-ended spanners (10, 13 and 17).
- Drain the fuel tank. Simply run the engine until the fuel tank is out of fuel and the engine stops. Alternatively, use a siphoning kit to dispense the remaining petrol in the jerry can (see the safety instructions included in Chapter 9.2).
- Remove the sparking plug (see Chapter 11.4.2). Spray some penetrating oil containing molybdenum disulphide into the cylinder through the spark plug hole. Then pull on the starter cord for the piston to reach the top of its stroke. Refit the spark plug.
- Places where the paint coating is damaged are repainted or covered with grease in order to prevent rust. ELIET original paints are available from your ELIET Dealer.
- Store the machine in a dry place that is protected against rain, and if necessary, cover it with a tarpaulin.
- Always allow the machine to cool down before storage.
- If the machine is to be stored outside, it must be well protected with a tarpaulin. Ensure that water does not directly fall onto the machine. ELIET strongly recommend that the machine is stored at a location that is well protected from the weather, etc.
- Never keep the machine in a place where it can come into contact with a naked flame source.

13. Equipment Specifications



Max. branch size	40 mm
Material throughput	12 wheel barrows of waste chippings an hour
Dimensions	1380 x 620 x 1220 mm
Storage dimensions	800 x 620 x 1040 mm
Feeding aperture	220 x 300 mm
Feed-in height	1200 mm
Transport wheels	Pneumatic tyres 400 x 4
Total Weight	50 kg
Knife drum	Steel shaft of 25 mm diameter 2 double steel knife discs 12 HS steel shred knives
Operating width	220 mm
Drive	5.5hp petrol engine Briggs & Stratton Intek
Available Options	Shredding screen for leaves and damp material Discharge funnel Carrying rack
Guaranteed A-weighted sound power level	110 dB(A)

EC-Declaration Of Conformity - MAESTRO

Machine: **SHREDDER**
Type: **ELIET MAESTRO**
Model number: **MA 001 050 922**
MA 001 050 114

The previously mentioned machine has been designed and manufactured to comply with the following European CE regulations :

"EN 13683: Garden Equipment -Integrally powered shredders/chippers -Safety"

ELIET mfg. cy. hereby declares that after performing a hazard analysis, it is fully aware of the potential hazards and risks associated with the machine. In this knowledge, the necessary steps have been taken in line with Machine Directive 2006/42/EC in order to ensure absolute operator safety for the operator, when the machine is used correctly.

The value of the measured sound power level and the guaranteed sound power level were obtained according the procedures set forward in the directive 2000/14/EG annex III/B clause 50 and directive EN 13683.

Measured sound power level LwA : 110 dB(A)
Guaranteed A-weighted sound power level : 111 dB(A)

Date: 01/01/2011

Signature:



Frederic LIETAER
Managing Director ELIET EUROPE NV
Date of birth: 02/01/1975

ELIET EUROPE NV
Diesveldstraat 2
BE - 8553 Otegem Belgium
Ph. +32 56 77 70 88 - Fax +32 56 77 52 13
info@eliet.eu - www.eliet.eu