

ELIET
MANUAL

Maestro City Electro



In this manual you will find information about the actual use and maintenance of the machine. **Read it carefully and keep it in a safe place.**



Please also keep your **purchasing invoice** or the proof of receipt together with this booklet.



Register your product online on **www.eliyet.eu**



Attention:

When putting a new machine into operation you must check the tension of all blade bolts during the first five working hours. Should this warning not be heeded, a blade may become loose. Serious consequential damage may occur in relation to your new machine and the operator may be in grave danger of suffering injuries or death may even be the result. ELIET can, as a consequence, not be held liable for the consequences of this negligence. Any claims on the warranty will also no longer apply.

© ELIET

Copyright 2018 ELIET. All rights reserved. All textual material, drawings, figures, diagrams, graphs, etc., included in this ELIET booklet are protected by copyright and also by other intellectual property rights. Nothing from this information may be copied for commercial goals or distributed and/or changed or reposted for other goals. Content has been included that specific places in this ELIET manual of which the copyright is the exclusive property of their respective owners.

1. Introduction



1.1 Carefully read this user manual

ELIET machines are designed for safe and reliable use if they are operated in accordance with the instructions given. Carefully read these operating instructions before using the machine. Failure to observe this may result in personal injury or damage to the equipment.

1.2 Identification data - ELIET MAESTRO City

Note the identification data relating to your machine in the boxed areas.

Stock N°	<input type="text"/>
Serial N°	<input type="text"/>
Engine:	<input type="text"/>
Year of Manufacture:	<input type="text"/>

2. Warranty



2.1 Registration of your machine

In order to be able to make a warranty claim, you will need to register your machine online within one month after purchase: www.elieta.eu / www.elieta.com

European customers: ELIET EUROPE NV
 Diesveldstraat 2
 8553 Otegem - Belgium
T (+32)(0)56 77 70 88 - **F** (+32)(0)56 77 52 13
www.elieta.eu

US customers: ELIET USA Inc.
 3361 Stafford street - USA
 Pittsburgh, PA 15204 - USA
P 412 367 5185 - **F** 412 774 1970
www.elietausa.com

Read the warranty conditions "read § 15. Warranty conditions" on page 47

3. Welcome



Welcome to the family of ELIET customers.

We would like to thank you for the confidence that you have placed in ELIET and we are convinced that you have purchased the very best machine. The operating life of your ELIET machine depends to a great extent on how you care for your machine. This user manual and the engine manual provided will assist you in this respect. If you follow the instructions and suggestions in these manuals, your ELIET machine will operate for a very long time in optimal condition. Read this instruction manual carefully before operating this machine. This will prevent you from operating the device incorrectly.

For your own safety, take into account the safety instructions stated in the relevant chapter. Even if you are thoroughly familiar with operating such equipment, it is still advisable to read these pages carefully.

At ELIET all our machines and devices are subjected to a policy of continuous change and therefore, the specification of your machine may differ slightly in terms of shape, technology and accessories. The descriptions and technical data in this manual are accurate at the time of printing. Certain illustrations and descriptions may not be applicable to your specific machine, but instead relate to a different version of the machine. In turn, we trust that you will understand that the texts and illustrations in this manual cannot lead to any claims.

If you still have any questions after you have read this manual, we request you to contact your ELIET dealer.

ELIET AT YOUR SERVICE

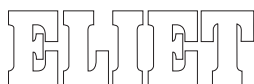

European customers GMT +1: 8 - 12 u en van 13 - 17 u

Zwevegemstraat 136
B-8553 Otegem
België

Tel: (+32) (0)56 77 70 88
Fax: (+32) (0)56 77 52 13
Email: service@eliet.be

US customers: ELIET USA INC

3361 Stafford street
Pittsburgh, PA 15204
P 412 367 5185 - F 412 774 1970

4. Table of contents

1. Introduction	3
1.1 Carefully read this user manual.....	3
1.2 Identification data - ELIET MAESTRO City.....	3
2. Warranty	3
2.1 Registration of your machine.....	3
3. Welcome	4
4. Table of contents	5
5. Operator safety warnings	7
5.1 For your information.....	7
5.2 Caution	7
5.3 Warning	7
6. Main parts	8
6.1. Machine description	8
6.2 Engine.....	9
7. Safety regulations	11
7.1 Safety messages	11
7.2 Safety features.....	14
7.3 General Safety Precautions.....	16
7.4. Guidelines related to the electric machines.....	19
8. Dealer Preparation	20
9. Operating instructions	23
9.1 Preliminary checks.....	23
9.2 Preparing the operating area.....	24
9.3 Using the Machine	24
9.3.1 Before Starting Work	24
9.3.2 During the work	25
9.4 Emptying the collecting bag.....	26
9.5 What to do about motor stalling	27
9.6 Cleaning the Machine.....	28
10. Transporting the machine	29
11. Maintenance	31
11.1 General	31
11.2 Maintenance schedule	32
11.2.1 Routine maintenance before each operation:.....	32
11.2.2 Maintenance after every 20 hours of operation:.....	32
11.3 Routine check prior to any operation	32
11.3.1 Visual inspection	32
11.3.2 Routine check of the blades	32
11.3.3 Sharpening the blades.....	34
11.3.4 Reversing and changing chipper blades.....	37
11.3.4.1 Work method for reversing the blades.....	37
11.3.4.2 Work method for replacing the blades.....	40

11.3.5 General lubrication treatment	43
12. Winterizing the machine.....	44
13. Equipment Specifications	45
14. EC Declaration of Conformity	46
15. Warranty conditions	47
16. Annexes	49
16.1 Hazard analysis	49
16.2 Opening and closing the shredding chamber	50
16.2.1 Opening the shredding chamber	50
16.2.2 Closing the shredding chamber	50
16.3 Removing and reinstalling the blade shaft	51
16.4 Dismantling the infeed hopper	53

5. Operator safety warnings



A number of symbols are used in this user manual to provide additional information and to highlight dangers.

5.1 For your information



For your information:

This symbol is used to draw your attention to specific information and/or actions, or to denote where you can find additional information relating to the subject.

5.2 Caution



Caution:

This notice identifies safe usage habits. This is done to prevent incorrect actions that can result in personal injury or damage to the machine.

5.3 Warning



Warning:

This notice is used to denote danger to consider in these specific circumstances. Thus remain alert, in order to ensure your own safety.

6. Main parts

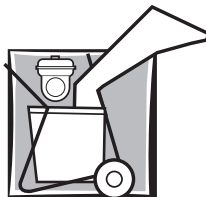

To fully understand the contents of this operator's manual, you need to be thoroughly familiar with the terminology used for the descriptions. In this chapter you can find a set of parts identified by name.

It's a good idea to take time to study the machine beforehand for an improved understanding of the descriptions given in this user's manual.

6.1. Machine description

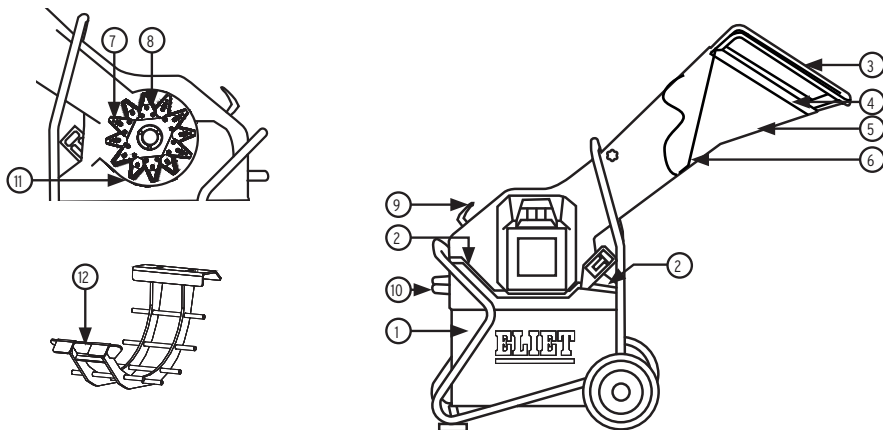

- | | |
|----------------------------|---|
| 1. Collecting bag (Output) | 8. Bearing |
| 2. Looking window | 9. Fastener-knob Sieve screen |
| 3. Handle for transporting | 10. Handle collecting bag |
| 4. Feed hopper (Input) | 11. Sieve screen |
| 5. Anti-projection guard | 12. Multi-purpose grating for wet green-waste |
| 6. Anti-projection rubber | |
| 7. Blade axle | |

6.2 Engine

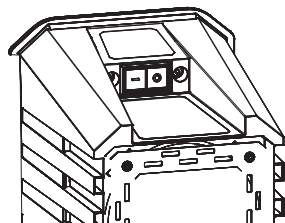

electric 3000W / 230V



For your information:

References in this manual to the right- or left-hand side, back or front, are viewed from the position where the chipper/shredder operator is facing on the side of the handle for transporting while looking toward the feed hopper (aka loading hopper).

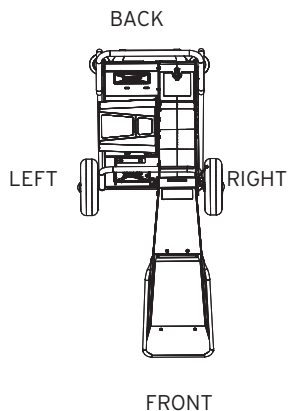

For your information:

Your ELIET Dealer is at your service, ready to provide you with maintenance or advice to keep your ELIET machine operating at peak efficiency at any one time. Parts and lubricants can be obtained from your ELIET Dealer. These service parts are manufactured to the same stringent accuracy and degree of craftsmanship as the original equipment.



Warning:

For your safety, use only genuine ELIET parts on ELIET machines.

7. Safety regulations



7.1 Safety messages

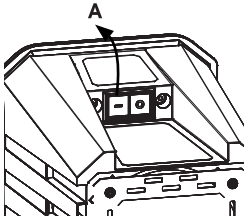

A. The starting button is green and provided with the “I” sign that is universally known as representing “on”. The stopping button is red and provided with the “O” sign that is universally known as representing “off”.



Decal location: On the left side of the feed hopper. This decal is used to denote all the safety precautions using icons.

1. Read this owner’s manual carefully in its entirety before attempting to operate this unit.
2. Always wear the appropriate protective garment when operating the machine (protective gloves, safety goggles, hearing protectors).
(Item number: BQ 501 020 310)



These icons are pictured on the left side of the feed hopper. They warn for the danger of cutting injuries to hands and to the danger of kickback material. Do not put your hands passed the safety protection screen.

(Item number: BQ 501 020 310)

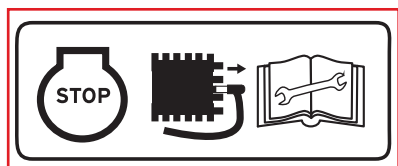

These icons are pictured on the left side of the feed hopper. When performing a maintenance to the machine, always turn off the engine. Put the switch on the engine to the OFF-position, in order to provide accidentally turning on the engine. Do not allow third parties near the machine while performing a maintenance. Always read the user manual before performing a maintenance to the machine or to the engine.

(Item number: BQ 501 020 310)



This sticker is put on the safety screen inside the feed hopper. This sticker warns the user of the danger of hand injuries and of flying debris. These are two risks - inherent in chipping branchy material - which are cared for by the safety screen. This sticker reminds the user how to operate the shredder in a safe way. No attempt should be made to put your hands past the safety screen!

(Item number: BQ 505 010 140)



This icon is pictured on the left side of the feed hopper. This sticker reminds the user to keep bystanders out of the area during machine operation.

(Item number: BQ 501 020 310)

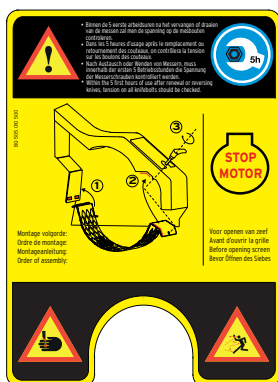

This decal is located on the protection chamber of the knife axle. It reminds the user to check the tension on the blade bolts regularly. The decal describes the manner of disassembly and assembly of the screen, and warns the user to switch of the engine before opening the screen.

The decal also warns the user for the danger of cut wounds to hands, and for the danger of debris projection when opening the sieve.

(Item number: BQ 505 010 500)

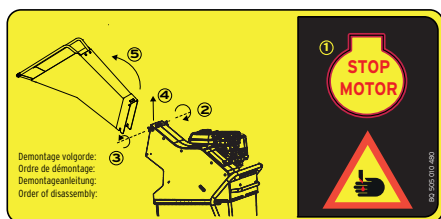

This sticker is located on the top side of the feed hopper. The way and manner of disassembly of the feed hopper is shown on this sticker. The feed hopper can be disassembled for transportation and for compact storing of the machine. The decal reminds the user to shut down the engine before disassembling the feed hopper. If disassembled there is an increased risk of contact with the blades and risk of cut wounds. (Item number: BQ 505 010 480)

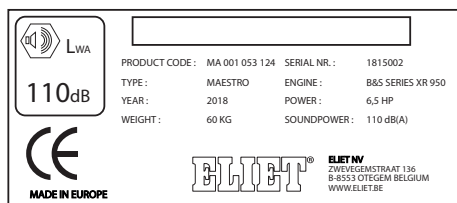

This sticker is used to indicate all the machine identification data.

- Year of manufacture
- Model
- Type number
- Serial number
- Power
- Weight
- Guaranteed A-weighted sound power level

Moreover, the sticker indicates all manufacturers' information.

The CE mark on the label testifies the conformity to European Standards.

7.2 Safety features

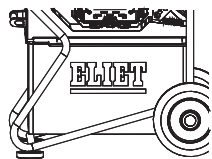

The collecting bag:

The collecting bag is located on the underside of the machine. Remove the collecting bag and the motor automatically shuts off. In so doing, the collecting bag prevents you from inserting your hands into the rotating shred knives. In order to prevent the collecting bag from opening when shredding, it is locked in its position with a powerful magnet.



Warning:

The knives may continue to rotate for a few seconds after the engine is shut off. Wait for 15 sec. before starting an intervention. Be careful not to cut your hands.

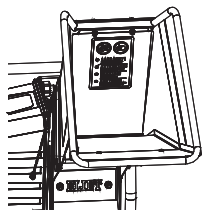

Safety screen:

The steel sheet located within the infeed opening, is specially designed to protect the operating personnel against flying wood chips. Any attempt by the operator to insert his hands beyond this steel sheet is strictly forbidden.

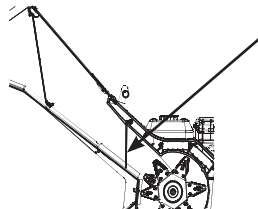

Anti-projection rubber:

At the entrance of the shredding chamber there is a synthetic flap that limits the fly-back of chips out of the shredding chamber. It is also a last shielding against involuntary contact with the blades.

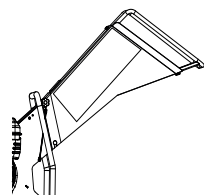

Feed hopper:

The shape of the feed hopper ensures the safety of the operator and is a protection against his personal carelessness. If the operator ignores the warning, and inserts his hands beyond the debris deflector shield, this hopper impedes access to the shredding chamber, making injuries caused by the shredding knives through the feed hopper virtually impossible.

Safety switch on the feed hopper:

The feed hopper is removable for compact storage. To prevent accidents from happening when the machine is working, a safety switch was installed. It shuts down the engine automatically as soon as the screws of the hopper are loosened. This also prevents the machine from being used without the feed hopper.

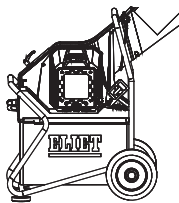

Rugged construction:

The robust construction not only adds to the long operating life of the machine but also provides extra user safety whenever there is an unforeseen emergency.

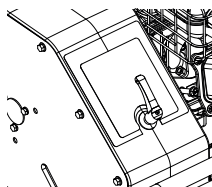

Sound absorption:

The double-walled acoustic housing accommodating the knife drum gives excellent noise reduction whilst shredding, therefore, minimising noise nuisance for both the operator and the surroundings.

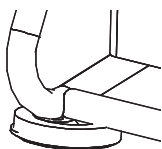

Rubber support feet:

The rubber support feet absorb vibrations of the machine, and they also have a restricting function. A machine on a slope will not slide down.

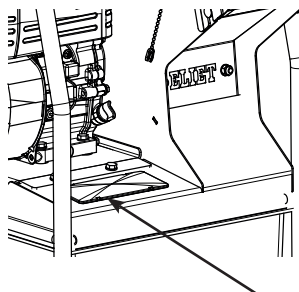

Looking window:

In the top plate of the chassis a sight glass is provided so that the user can control at all times in a safe way the volume in the collecting bag.

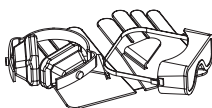

Safety wear:

For your safety, we strongly recommend to use the safety kit supplied as standard. It contains your Personal Protective Equipment (PPE): that is, safety goggles, ear protections and protective gloves.

7.3 General Safety Precautions

- The owner must keep the manual during the complete service life of the machine. It serves as a reference for the user, therefore, enabling the machine to be used and maintained in accordance with the correct instructions. (This manual is part of the machine)
- This machine is designed solely for shredding branchy material, pruning, leaves and all kinds of organic garden debris. Any use other than the designated operation is at the risk and responsibility of the operator.
- According to the manufacturer, this model will take branches up to 35 mm - 1" 3/8 diameter. Branch feed is not mechanically limited to this stated capacity ; it follows that any attempt to introduce thicker branches must be avoided. For your own safety on no account should any attempt be made to introduce stems thicker than the stated capacity.
- Never attempt to shred branches that are frozen.



Warning:

Accepting branches with diameter up to 35 mm - 1" 3/8, this machine, however, is not designed for continuous shredding to the stated capacity. In the interest of your own safety, it is recommended that only 10% of the green waste exceeds this diameter.

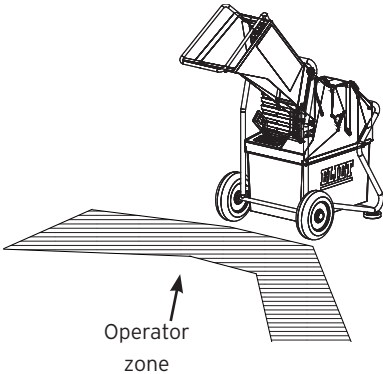

- This equipment must only be operated when stationary. Make sure the tyres and the frame are in contact with the ground.
- The operator's position when shredding is the surrounding area within arm reach located on the front of the infeed opening.
- Never use a step for feeding the machine with material.
- The equipment must under no circumstances be modified.
- Do not use the machine without feed hopper

- Observe all safety instructions when using the ELIET machine! Carefully read the instructions on using the machine. All these instructions relate to your personal safety. Read the chapter that is meant for the Dealer (“read § 8. Dealer Preparation” on page 20) to find out whether the machine has been delivered as per instructions.
- On delivery of unit, first allow the Dealer or a professional to give you some instruction.
- Read and observe all safety messages posted on the machine in the form of decals.
- It is assumed that the operator of this machine is mature enough and has enough common sense to make decisions by himself.
- All persons using the machine are assumed to be familiar with the safety instructions. **The operator is fully liable for the use of the machine in regard to himself and to third parties.**
- Underage persons must not operate the machine. This does not apply to youths above the age of 16 years, who are learning to operate the machine under the supervision of an experienced operator. Children and animals must be kept well away from the machine.
- ELIET recommend that the machine should not be lent to others. However, if this is done, only lend it to persons who are familiar with the machine. Always ensure that the user is aware of the potential hazards, and ensure that he reads the manual before using the machine.
- This machine must only be operated by persons who are in a good physical condition. If you become tired during the work, take a rest in due time. Persons consuming alcohol or drugs must not operate this machine.
- You must wear proper apparel to operate this machine. That is, clothing covering the whole body, heavy protective gloves and closed nonslip footwear.
- Do not wear loose fitting clothing (a shawl, for instance, should be avoided by all means). Long hair should be contained using a cap or a headband, or worn in a ponytail.



Caution:

For the protection of the most sensitive senses, ELIET recommend hearing protectors and a safety goggle. These are included with the machine.

- Never work in conditions where the light intensity is less than 500 Lux.
- During work parties, do not allow bystanders to come within the risk zone that stretches up to 5m - 15 ft around the machine.
- When leaving the machine, the engine must be switched off.
- When parts must be renewed as a result of wear or failure, you must always request genuine ELIET service parts from your ELIET Dealer. This is important in the interests of your own safety.

- Use the machine in a manner respecting environmental regulations.
 - a) Avoid unnecessary machine running while not at work.

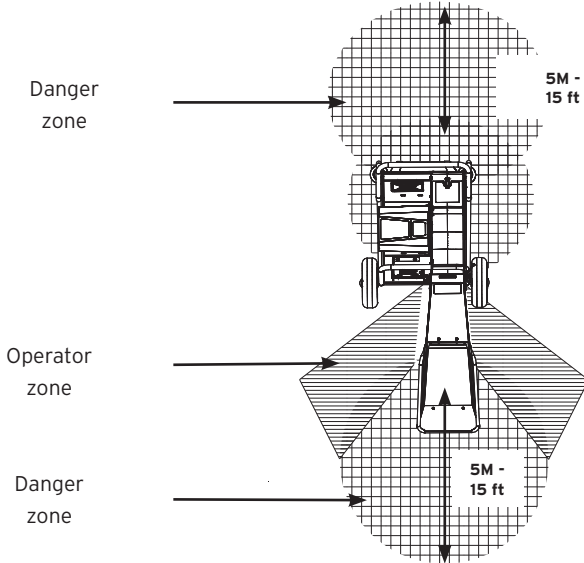

- When leaving the machine, the motor must be switched off and the machine must be disconnected from the electric mains.
- When parts must be renewed as a result of wear or failure, you must always request genuine ELIET service parts from your ELIET dealer. This is important in the interests of your own safety. (Find an official ELIET dealer near you by visiting .)

Handle the machine in an environmentally conscious manner:

- a) Do not run the machine unnecessarily without being at work.

7.4. Guidelines related to the electric machines

On machines powered by an electric motor, the following guidelines must be observed as well.

A. Related to the Maestro City Electro

Below we supply the specific features of the motor:

City: 230 V 50 Hz P: 3,000 W In: 13.6 A $\cos \varphi$: 0.96 n : 2,820 rpm Capacitor: 40 μF

- The motors should be supplied from a one-phase alternating current line (AC) with voltage 230 V and frequency 50 Hz. Check the characteristics of the electrical supply. Consult your energy supplier or an expert should you lack information regarding this issue.
- The overcurrent protection of the mains network will have a fuse of 16A. The overcurrent protection must have a response time that is in accordance with the C curve.
- Mains networks with a higher protection (overcurrent fuse < 13A) may disrupt the good operation of the machine because it is tripped too often.
- Ensure that no other high-power devices are connected to the line dedicated to supplying the machine. Switch off any other device or connect them to another circuit.
- Avoid electrocution: Therefore, always use 3-wire extension cords (3 x 2.5 mm² : L1, L2, earthing) of which the plug is fitted with a ground pin.



- Never use an extension cord that is longer than 20 m.
- The plug that is connected to the machine must correspond with the model as described in the specifications below.
- Germany, Belgium, the Netherlands, France, Italy, Spain and Austria: Type E & F CEE 7 (female)
- United Kingdom: Type G BS 1363 (female)
- Switzerland: Type J SEV 1011 (female)

8. Dealer Preparation

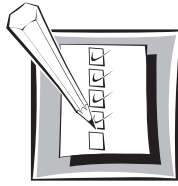

Warning:

As an ELIET Dealer you should familiarise your customers with the machine functions and also point out the possible dangers while using it. You are expected to carefully go over the maintenance points of the machine together with the new owner. You are supposed to repeat these instructions until the new owner has fully understood everything.



The manufacturer, ELIET, wish to re-emphasise that the Dealer must expressly point out to the customers that they must examine the bolts which retain the shredding knives for security of fixings after the first 5 (five) operating hours.

When the machine has been removed from its packaging, it is still not completely assembled. Your ELIET Dealer is expected to complete these preparation steps. Following are a few guidelines.

Content of the box:

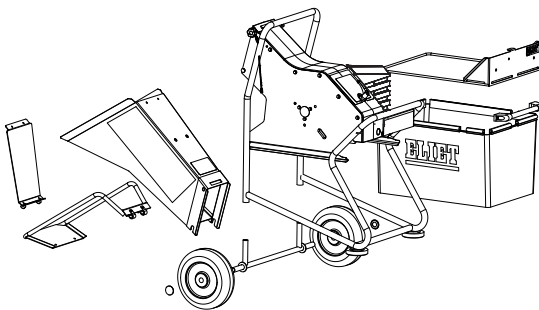

- Machine
- Feeding hopper
- Handle feeding hopper
- Two wheels
- Wheel support
- Collecting bag
- Hardware kit for assembly
- Protection plate
- Set personal protection
- Manual

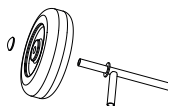

- First apply some grease to the shaft from the wheel holder. Now slide the wheels with stem facing outside on the shaft and secure them using the starlock fasteners.



- Next, slide the wheel holder into the machine chassis. Push the wheel holder in even increments until the frame tubes are a sliding fit over the vertical tube ends of the wheel holder. The wheel holder can be locked in this position by screwing an M8 bolt in the provided nut on the right frame tube.

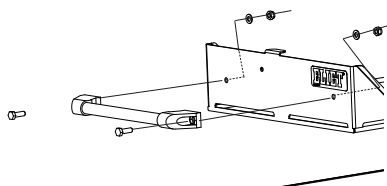

- Mount the handle of the collecting bag. Slide the synthetic tube on each side of the tube holder. These are firmly bolted to the frame using the bolts and nuts that are included. (2xM6 - Wrench 10)

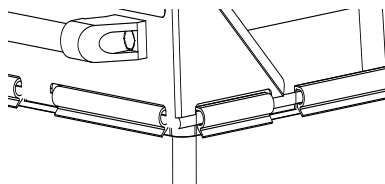

- slide the frame for the collecting bag out of the chassis. Now clip the plastics around the frame as depicted

- To mount the handle to the funnel screw this in the upper side in the vibration dampers where the anti projection shield is mounted. To prevent the anti-projection plate, at a breaking down the rubbers would end up in the blade system, it is mounted between a nylon safety trip. (see drawing below)

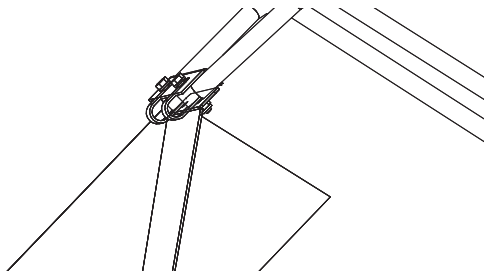

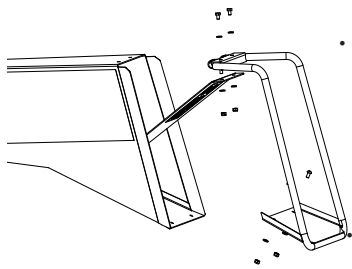

- Place the handle in the feed hopper, align the upper holes. Insert a M6 bolt with flat washer true the feed hopper and handle. Slide a nylon strap on the bolt and screw the bolt into the rubber silent bloc. Same for other hole and tighten (wrench #10) till handle hit the feed hopper.

Now take the protection plate. Slide first the nylon strap on the treads from the silent blocs and put the protection plate in place. Use a flat washer and an M6 nut to hold the protection plate in place (wrench #10).

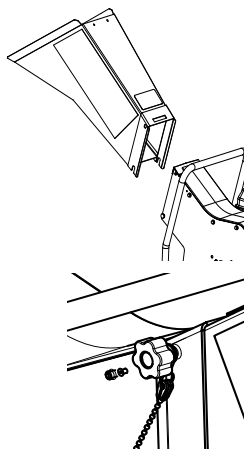

- Next we fix the handle at the bottom. Take 2 hex bolts and 2 flat washers and insert them from the top and use 2 flat washers and 2 M6 nuts and tighten (hex #4 wrench#10).

- Once the wheels are under the chassis, you will mount the feed hopper. Slide the feed hopper over the neck in order that the 2 slits hook onto the chassis pins and position the upper part in order that the recessed channel in the feed hopper hooks on the long notch from the chassis (this will keep the feed hopper in place). Put some grease on the thread of both screws (hanging on the chain). Now turn the screw on both side till tight (without those at the end the safety switches will disactivate the engine).

9. Operating instructions



9.1 Preliminary checks



Caution:

Before commencing the work, it is recommended to get into the habit of checking the following points.

Checklist

1. Satisfy yourself that the shredding knives are firmly in place and in good condition. If they need to be sharpened, this must be done first. Check the knives for cracks and nicks and replace immediately as needed (“read § 11.3.4 Reversing and changing chipper blades” on page 37).
2. Check whether the screen at the rear of the machine is secure, and has been fastened in the correct manner.
3. Verify that all of the machine’s safety items are operating correctly. (“read § 7.2 Safety features” on page 14).

Once these items have been checked and approved, you can prepare the area of operation (“read § 9.2 Preparing the operating area” on page 24) and move the machine to the work site.

9.2 Preparing the operating area

- Clear the area first where the machine is to be used. In addition, the paths along which the plant trimmings are removed, must be kept clear, thus releasing the operator from the worries of tripping up over them. The operator must also ensure that his safety is not compromised.
- On slopes, never operate the machine (no forward or lateral slope).
- Sort out as much as you can before you start the machine up. In this way, you are pretty sure that no foreign objects will enter the machine with the material to be shredded.
- With foreign objects are meant: any non-organic object or branchy material in excess of the stated capacity (such as metal, stone, plastic, pvc, cords,...). Some of these can cause serious damage to your machine or can be ejected, virtually as projectiles towards the user.
- Always position the machine so that the wind will blow the dust produced away from the engine.

9.3 Using the Machine

9.3.1 Before Starting Work

- Wear proper apparel, protective gloves and safety equipment as instructed in this manual (“read § 7.3 General Safety Precautions” on page 16).
- A good gardener is well organised and plans his work. This will enable him to have an overview of the work and to avoid accidents and incorrect actions with the machine..
- The wood is systematically stacked before commencing the work: thick branches, thin branches, leaves and damp material. Ensure that the material does not contain any foreign objects.
- The engine must only be started once arrived at the work site.

**Caution:**

Once the engine is running, the shredding knives are rotating, therefore, irrevocably shredding anything that is introduced into the feed hopper.

9.3.2 During the work

- You must be careful when performing work. As long as you're operating the machine, focus your concentration completely on the work.
- When inserting the material, always hold it firmly. The rotational direction of the knife drum makes for steady material feed into the hopper. If you stop holding the wood firmly, it will automatically be pulled much too quickly into the machine which will inevitably lead to the machine stalling.
- You yourself will thus control the speed at which the wood is fed in (faster or slower). The speed at which the wood is fed in will vary according to branch size.



Caution:

When feeding in wood, never insert your hands beyond the steel shield. By raising the safety screen, you are no longer protected against wood chips flying out of the machine.

- If the equipment is primarily used for shredding leaves or damp material using the standard sieve screen, the chances are that the screen will clog. To avoid this Eliet has a special screen-option item **MA 001 052 001** available for purchase.
- If only a small volume of leaves is to be processed, they can be easily shredded using the standard screen. However, in this case, ELIET recommend that leaves and branches should be shredded alternately. In so doing, the wood chips prevent the screen orifices from clogging.
- As the waste chippings are collected in a collecting bag, care must be taken in making sure at regular intervals that the chips will not block the discharge situated on the underside of the machine. Collecting bag filling can be checked by looking through
- To promote collecting bag consolidation, shake the bag regularly to distribute the waste chippings to fill the empty spaces in the collecting bag.
- If you should notice that, despite all of the preparation, a foreign object still finds its way into the machine, the engine must be immediately shut off. The foreign object must be removed first and then the machine must be examined for damage. If damaged, have the damage repaired promptly.
- As a rule, the engine will shut off automatically on removing the collecting bag. If not, possibly as the result of an electrical defect, immediately turn the engine off yourself and refrain from using it until repaired.

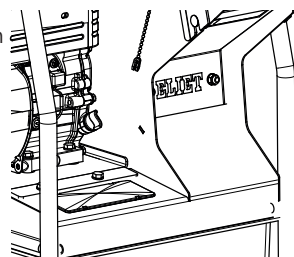

REMOVING THE Collecting BAG = MOTOR SHUT OFF

Normally, the engine shuts off if the feed hopper is loosened. If this is not the case, the machine operator will turn off the machine manually with the switch on the motor. The defect must be fixed immediately before proceeding the work.

REMOVING THE FEED HOPPER = MOTOR SHUT OFF

9.4 Emptying the collecting bag

- The bag needs emptying when the waste chippings in the collecting bag has reached the bottom of the discharge chute of the machine.
- In order to do so, always first make sure to shut off the engine (failure to do so will cause the engine to cut out automatically on collecting bag removal).
- Failure to empty the bag in time will cause the shredding chamber to get clogged up and finally come to a stop. (“read § 9.5 What to do about motor stalling” on page 27)



Caution:

A machine that does clog up is a sure source of overheating with the resultant increase in fire hazard.

- The collecting bag has an approximative 60 L / 16 US gallon capacity.



Warning:

Once full, the collecting bag can be pretty heavy. Which means - make sure to hold the collecting bag close in towards your body as close as possible first and then lift using your leg muscles. (Lift keeping back straight and bend legs at the knees.) Know your own capability. The mere fact of lifting things beyond your personal capacity a mere few centimetres does serious damage. Seek assistance when lifting things that are too heavy for you.

- Either you can empty the contents of the collecting bag in to a wheel barrow, or you can carry the full bag to the dumping area using the wheel barrow.
- What's more, the machine can be used for transporting the collecting bag once full.
- When refitting the collecting bag you can secure it in position using locating pins.

9.5 What to do about motor stalling

Motor stalling can be traced to overloading, overfeeding, discharge blockage or the power supply being down. You can very simply restart the chipper in these cases. Proceed as follows :

1. Check that the extension cord has not become loose. Both at the machine and the connection to the electric mains.
2. Remove all branches from the feed-in opening.
3. Check whether the chipping chamber is already full and whether wood residue may not be blocking the blade shaft.
4. Empty, if required, the chipping chamber to make restarting easier. Open the chipping chamber in accordance with the procedure described in annex 2.



Caution :

Always wear gloves when performing maintenance. You will be near the blades when emptying the chipping chamber. They are razor-sharp and, therefore, represent a real risk of leading to cutting injuries. Take care and try to avoid all contact.

5. Check whether the motor protection relay on the machine or the mains fuse has tripped. When the motor is overloaded, the overload protection will automatically push out the green start button.
6. The red stop button may have been pressed unintentionally.
7. Just try to push the green start button again. Check through the window to see whether the blade shaft is not again starting up.
8. Should the motor make an abnormal humming noise, this may point to a blockage and the issue must be further investigated or an official ELIET dealer must be consulted.
9. Should the green start button immediately protrude again, this may mean that the motor is still overheated and that you should allow it to cool down.
10. Should there be no reaction when you press the star button and the motor does not seem to want to get started, this may mean that one of the safety switches has been deactivated. Check whether the collection box has been correctly positioned and whether the window elements have been correctly mounted. If the machine does not want to start up after checking these two points, consult your official ELIET dealer. (Find an authorized ELIET dealer near you by visiting www.elietau.eu.)

Perform the work more carefully in the future in order to avoid jamming of the machine.

Should you notice a strange noise after the machine starts up, immediately stop the machine to prevent consequential damage. Stop the motor, disconnect the plug and investigate the cause of the defect. Before proceeding, have the necessary repairs performed.

9.6 Cleaning the Machine

If the machine is not cleaned, this will lead to increased wear. If the machine does not operate optimally, this can compromise the safety of the user.

Disadvantages associated with non-cleaning:

1. Increased wear on bearings
 2. Increase in sealing wear rate
 3. Reduced cooling efficiency
 4. Fire hazard
 5. Inability to detect fractures or cracks
 6. Damage to paint coating
 7. Stickers becoming illegible
- Each time after the machine is used, make it a habit to spend some time cleaning the machine. The cleaning of the machine can also be considered to be a visual check. This lets you detect cracks, breaks or lack of lubrication in time.

Special attention must be paid to the following items.

- The engine must remain free of dust and dirt. In particular, the cooling fins must be clean and the area around the exhaust pipe must be unobstructed.
- Using a dry cloth, remove any dirt from the chassis. Pay special attention to places where stickers with safety messages are displayed.
- Decals used to indicate safety messages, that are no longer legible must be immediately replaced. Obtain these original decals from your ELIET Dealer.



Caution:

Wear proper apparel when cleaning. Gloves are required.

- When cleaning, use a dry cloth, soft brush, etc. To remove grease, use penetrating oil containing molybdenum disulphide. This spray lubricates and also dissolves rust. (Do not use any cleaning products that affect paint or stickers.)
- Steam cleaning of the machine is permitted. However, never point the water jet for long periods in the direction of bearings, electric contacts or filler caps. Water is known to be the main cause of corrosion and must, therefore, be avoided at all times. Allow the engine to cool down prior to cleaning it down with a cold water spray.

10. Transporting the machine



- Make sure to clear the shredding chamber before moving the machine. Make sure the infeed opening is free of branchy material.
- When moving the machine over greater distances (over 2m - 8ft), always take care to turn off the engine.
- The chipper is designed to be in stationary position while working. This means that both the wheels and support legs are on the ground. To transport the machine you have to put it in transport position. To do this, grab the handle to the funnel and tilt the machine to the front till it is in a balanced position. (The handle is on +/- 70 cm - 27 1/2" of the ground).

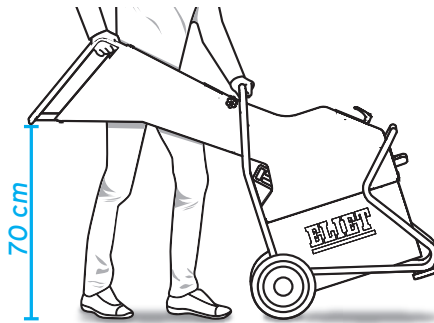

- Then, grasp the chassis upper tube with your left hand while holding the feed hopper handle with your right hand. In so doing, you can hold the machine with a firm grip for smooth pulling and pushing.
- Only adults may move or transport the machine.
- Also, during the transport, do not allow children, unauthorised persons or animals within a radius of 5 m - 15ft around the machine.
- The infeed hopper can be disassembled for an easier transportation of the machine in a car. ("read § 16.4 Dismantling the infeed hopper" on page 53) .
- To slide the wheel holder out of the frame, tilt the machine 15 cm - 6 inch over the support feet till the wheels are about 15 cm - 6 inch above the ground. Put your foot on the connection tube between the wheels and push it down out of the chassis. (First, check whether the wheel holder is not secured to the right lower side with a pressure screw (M8).

- Use slip resistant ramps to load the machine into a van or a trailer. Ensure that those are well secured to the vehicle or trailer.
- Assure yourself the parking brake of the vehicle is on before loading the machine.
- Under no circumstances must the angle of the ramp be greater than 25°.
- Be careful and composed when loading and unloading the shredder so that the machine does not tip over and give rise to an accident.
- In the event that the machine does tip over, right it again as soon as possible. This prevents oil from leaking out of the crankcase on to the air cleaner.
- Try to prevent the motor from falling over, since these filters are expensive.

- When walking up a slope push the chipper out in front of you with you facing uphill.

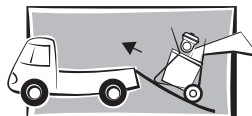

- When walking down a slope, move down backwards with you facing the machine.

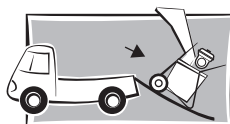

- The machine must be properly tied down within the vehicle during transport. Use the tube-gear to attach ropes.
- Do not overload the vehicle. .“read § 13. Equipment Specifications” on page 45 to find out the exact weight of the shredder.
- The maximum allowable lateral slope angle is 10°

11. Maintenance



11.1 General



For your information:

The dealer's personnel are always at your service. ELIET Dealers can always rely on comprehensive support from ELIET, so that they can work together to find a solution for any problem that you may have.



Caution:

Only use genuine ELIET replacement parts. These service parts are manufactured to the same strict quality control and degree of craftsmanship as the original equipment.

- For your own safety, only genuine service parts must be installed on the ELIET machines.

Perform maintenance in a room intended for this purpose. This area must have the following features.

- spacious
- Well lit.
- clean and tidy.
- easy access
- Dust-free.
- Quiet.

These characteristics are important to enable maintenance to be performed in an optimal manner.



Caution:

Maintenance performed in an incorrect manner may compromise the operator's safety.

- Maintenance should be always carried out with the engine turned off.
- Always wear safety gloves when performing maintenance. Safety goggles may be required for certain operations. These are supplied with the machine.

TIP:

The maintenance work described can essentially be performed by any person who possesses the requisite technical knowledge. However, ELIET recommend that the machine should be handed in to an ELIET dealer for a maintenance each year.

Your ELIET dealer is always at your service for maintenance and advice. He stocks genuine ELIET service parts and lubricants. His staff can always obtain advice and service from ELIET, so that they can provide you with the best after-sales service.

11.2 Maintenance schedule

11.2.1 Routine maintenance before each operation:

- Visual check of the stat of the machine ("read § 11.3.1 Visual inspection" on page 32)
- Inspection of the blades ("read § 11.3.2 Routine check of the blades" on page 32)
- Sharpening the blades ("read § 11.3.3 Sharpening the blades." on page 34)

11.2.2 Maintenance after every 20 hours of operation:

- Reversing and/or replacing the blades ("read § 11.3.4 Reversing and changing chipper blades" on page 37)
- Cleaning the machine ("read § 9.6 Cleaning the Machine" on page 28)
- General lubrication treatment ("read § 11.3.5 General lubrication treatment" on page 43)

Lubricants

Engine	SEE ENGINE MANUAL
Bearings	NOVATIO PTFE OIL / PENETRATING OIL ON MoS2 base
Wheel axle	SUNOCO GREASE MULTI-PURPOSE LR - EP2

11.3 Routine check prior to any operation

11.3.1 Visual inspection

Check that no parts have been deformed, that welded seams are not cracked and that parts are not excessively loose. If problems are found, carry out the necessary repairs first. Check that the machine is running at the correct rpm (3200 rpm) (an rpm meter can be obtained from you ELIET dealer). Never attempt to change the default settings of the engine.

11.3.2 Routine check of the blades

Sharp chipping blades will give the machine optimum performance and provide maximum operating speed. Enhance your own work comfort by taking some time to check the blades, and if necessary, sharpen them.

SHARP BLADES = MAXIMUM OUTPUT

- Before performing any maintenance, stop the machine



Warning:

The blades may continue to rotate for a few seconds after the motor is switched off. Always check whether the blade shaft has come to a complete standstill.



Caution:

Always wear gloves since blades can be razor-sharp

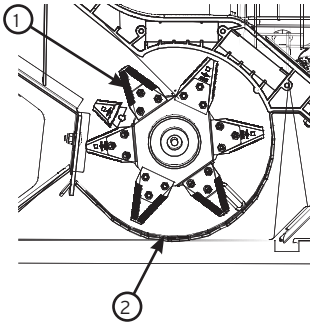

- Open the shredding chamber (“read § 16.2 Opening and closing the shredding chamber” on page 50).

Pay particular attention to the following:

Garden waste chipping with the ELIET chipping system takes place in two steps. We first have the contact of the blades with the garden waste when chopping takes place where the cutting block can be found. The wood and garden waste is cut in large, rough and irregular chippings during this **primary chipping (1)**. These large chippings will, subsequently, end up in the shredding chamber where they are finely chopped to produce small chippings. This **secondary chipping (2)** will continue until the chippings are considered to be small enough to pass through the openings of the calibrating sieve.

Each of these chipping actions set certain criteria that the blades must meet for optimal chipping efficiency:

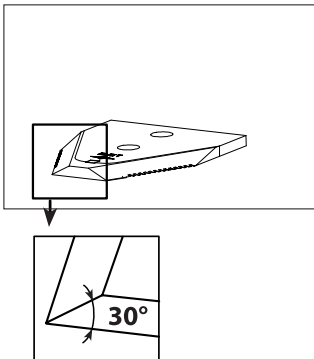

A) The top of the blade, in particular, is important with regard to the primary chipping. Since the blades act as splitting blades, the cutting angle is essential because this forms the key that will cleave through the wood. The **cutting angle** of the cutting edge of the blade is by preference 30°. The sharper the blade edge, the less resistance when splitting and the smaller the cutting impact on the structure. This will ensure considerably fewer vibrations and noise. This will also benefit the load on the blade shaft and the bearings. The blades must be regularly ground to guarantee the optimum cutting angle. (“read § 11.3.3 Sharpening the blades.” on page 34)

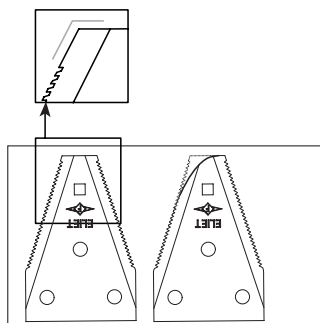

On the other hand, the form of the top of the blade is of essential importance for the performance and the speed of this primary chipping. The angle of the **top of the blade** will determine the angle at which the wood is pulled inside the shredding chamber. If this angle is rounded due to wear, the blades must be reversed and/or replaced. ("read § 11.3.4 Reversing and changing chipper blades" on page 37)

B) The issue is to have the chippings leave the shredding chamber as quickly as possible with regard to the secondary chipping. The chippings, therefore, must be quickly reduced until they are small enough to pass through the openings of the calibrating sieve. Every contact with the cutting area of one of the blades must, therefore, ensure that the chippings become smaller. Therefore, **the sharper the full active cutting edge** of the blades is, the more efficient chipping will be. Regular grinding of the cutting edge is, therefore, required.

Cutting edge teething ensures that the cutting power of the blades increases and the cutting edge remains sharp for a longer period of time. It is very important to never grind away the teeth when performing maintenance on the blades. ("read § 11.3.3 Sharpening the blades." on page 34)

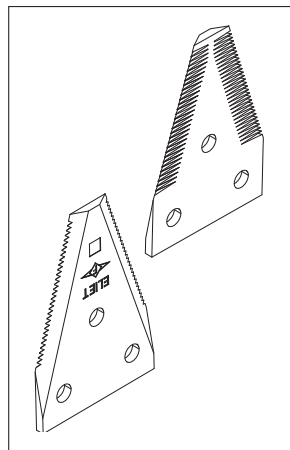

The position of the blades on the blade shaft has been selected very specifically to obtain an alternative chopping configuration with regard to primary chipping and the correct circulation of the chippings in the shredding chamber with regard to secondary chipping. You must, therefore, always ensure that you respect the original set-up when reversing or replacing blades.

("read § 11.3.4 Reversing and changing chipper blades" on page 37 where the rules are explained.)



11.3.3 Sharpening the blades.

Correct and timely Sharpening of the chipping blades will extend blade life. (ELIET recommend the following: Grind after at least every 10 working hours.)

Preparatory warnings

- Always wear safety glasses and hearing protection when Sharpening blades. Wearing gloves is also mandatory when performing any maintenance.
- NEVER rotate the blade shaft by grabbing the blades. Use a tool to grab the blades.
- The blade has two cutting edges (reversible blade). This means that you must take into account when Sharpening that there is another razor-sharp blade side.
- Open the shredding chamber (see Annex 2).

- Remove the blade shaft from the machine to grind blades (see annex 3).
- For safety's sake, firmly clamp the blade shaft (i.e. In-between a bench vice) and ensure that this cannot twist, move or fall unexpectedly during maintenance and, thus, injure someone.



For your information:

The blades do not have to be disassembled for Sharpening. Use for this a small angle grinder equipped with a grinding disc suitable for steel.

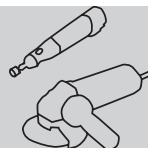

Caution:

Lit sparks will fly around when Sharpening the blades. They may start a fire. Bear this in mind when selecting the work site. Never grind blades near fuel or lightly flammable products. Always have available a fire extinguishing resource in the immediate vicinity.

A blade has two sides.

- The front of the blade has the two chamfered cutting edges. **(F)**
- The rear clearly shows the tooth profiling of the cutting area. **(B)**

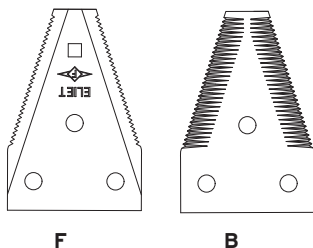

As described in "read § 11.3.2 Routine check of the blades" on page 32, a sharp blade edge and a correct cutting angle are essential for efficient chipping. Blades must be correctly ground to ensure these two features can be realised.

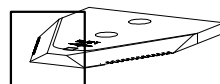

- If blades become blunt, the sharp cutting edge will become worn and will be upset to form a wider rib. **(1)**
- By Sharpening a little metal from the cutting edge, you can again obtain a sharp cutting edge from this wide rib. **(2)**
- Sharpening is performed by moving the grinding disc along the angled cutting edge.
- Note: By regularly grinding, you will only have to grind away a small adjustment of the metal each time to again obtain a sharp cutting edge. This will ensure for very short grinding times and you will always have the best possible cutting edge. (ELIET recommend the following: Every 10 working hours.)
- Avoid grinding at the same location for a longer period of time. This will prevent local discolouration of the blades, which would indicate heating and, therefore, the material structure at these places will change and the hardness will decrease.
- It is extremely important that the existing cutting angle be respected when grinding. **(3: Incorrectly ground blade)**
- If the cutting angle is not maintained, blades will be stopped in the wood due to a blunt angle **(4)** of an interrupted cutting angle **(5)** and a lot of power will be lost. Too sharp a cutting angle **(6, 7)** will give rise to a weakened cutting edge and, therefore, blade life will be considerably shortened (see figures 4, 5, 6 and 7).

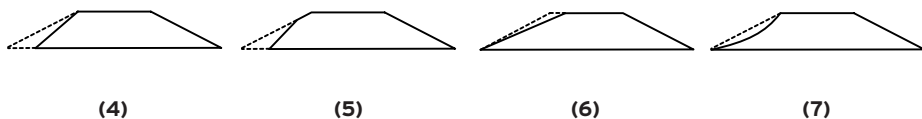
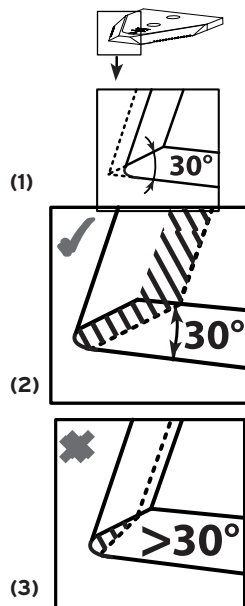

- Never grind the rear side of a blade. The profiling is on the rear with regard to RESIST/6™ blades. If you grind away the teeth, the blade will lose a great deal of its cutting force.
- The top of the blade is subjected to the heaviest loads during chipping. You should, therefore, grind them as little as possible to avoid weakening.
- After all, a little of the material is removed every time they are ground and, therefore, the active cutting edge becomes smaller. You can continue grinding up to halfway the width of the blade tip. If you exceed this limit, you will be compromising blade life of the unused cutting edge. We recommend reversing the blades at this point (“read § 11.3.4 Reversing and changing chipper blades” on page 37).
- If the tip of the blade is rounded-off, chipping efficiency will be reduced. In this event, further grinding of the blade serves no purpose. This is the time to reverse or replace the blades. (“read § 11.3.4 Reversing and changing chipper blades” on page 37).
- After grinding, refit the blade shaft into the machine. (“read § 16.3 Removing and reinstalling the blade shaft” on page 51.)

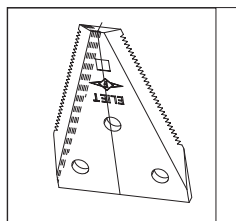

- Carefully close the shredding chamber after Sharpening. (“read § 16.2 Opening and closing the shredding chamber” on page 50)

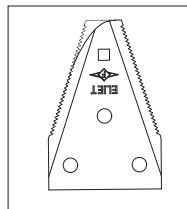

11.3.4 Reversing and changing chipper blades

If the blades are regularly ground, a blade life of more than 50 hours can be guaranteed per cutting edge. When one cutting edge is totally used, you can reverse the blade and you will have another 50 hours. If both blade edges are worn, replace the blade as a whole.



Caution:

Any entitlement to claim on the guarantee will be excluded in case of damage or consequential damage that occurs due to faulty maintenance of the blades. Consult your official ELIET dealer for advice if required.

11.3.4.1 Work method for reversing the blades



Warning:

Wear protective gloves as the blades are razor sharp!

- Stop the machine and disconnect the power supply extension cable from the machine.



Warning:

The blades may continue to rotate for a few seconds after the motor is switched off. Always check whether the blade shaft has come to a complete standstill.

- Open the shredding chamber (“read § 16.2 Opening and closing the shredding chamber” on page 50)
- Remove the blade shaft from the machine to reverse the blades. (“read § 16.3 Removing and reinstalling the blade shaft” on page 51.)
- For safety’s sake, firmly clamp the blade shaft (i.e. In-between a bench vice) and ensure that this cannot twist, move or fall unexpectedly during maintenance and, thus, injure someone.

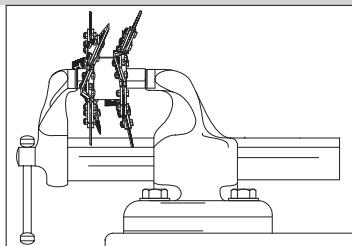

There are a few rules that must be respected for reversing or replacing the blades. First we will examine in detail the construction of the blade shaft to understand the logic behind the rules:

- A Maestro City blade shaft has been constructed from two identical blade discs that each contain 6 blades.
- Although the blade discs are identical, they are offset 90 degrees from each other around the central shaft.
- The two blade discs have been welded on the central shaft. This shaft is not symmetrically positioned with regard to the volume of the two blade discs:

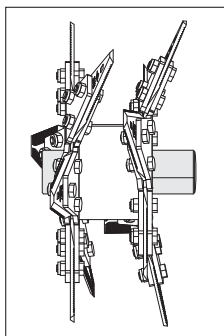
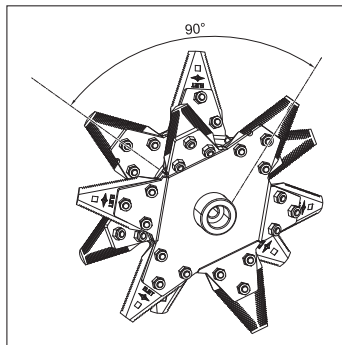

- On one side, there is a long protruding shaft section in which a large bore is provided that is meant for sliding on the motor shaft: This side will be referred to as follows from now on: The **motor side (M)** of the blade shaft.
- On the other side, there is a short protruding shaft section. This is the place where the retaining screw is placed to fix the blade axle on to the crankshaft of the engine. We refer to this side as: The **tightening side (O)** of the blade shaft.

- Take note that each blade has two sides.

Front (F): The side with the chamfered cutting edge.

Back (B): Side with the clearly visible tooth profile.

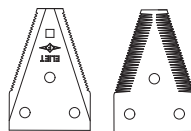

(F)

(B)

- It catches our attention that the orientation of each blade is different on the blade disc. A special order is involved when positioning blades. We recommend numbering the blade positions to ensure the order is respected when the blades are reversed.

- Blade discs can occupy six different positions. Therefore, the **blades** and the **matching positions** must be numbered from 1 to 6 on the blade holder using a pen.

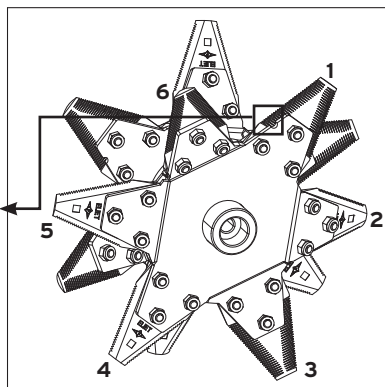
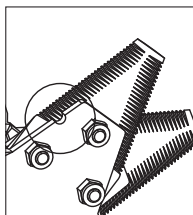

- Always start numbering in clockwise direction (as viewed from the "tightening side") from the right blade position that has a small recess.
- Do the same for the second blade disc.

Each blade is held in place with three M6 bolts. Fully loosen the nuts of each blade and remove the bolts.



For your information:

Remove and refit one blade at a time. This ensures that reversal is performed in an orderly manner.

TIP: There are 36 bolt connections in each blade shaft. ELIET recommend using a pneumatic ratchet wrench to quickly loosen these. Place a ring spanner on the bolt head and loosen the nut using the ratchet wrench ratchet. (SW 10)



Caution:

If you loosen the bolt connections manually, avoid injuries to hands by using two ring spanners with long handles. (SW 10)

- Replace damaged bolts and nuts immediately. (Part Nr. bolt: BS 511 000 618 ; nut: BS 502 000 600)
- Do not pull away the blades using your hands but use a self-grip wrench.
- It is useful to put a wedge (screwdriver) in-between the blade discs to ensure it is easy to release them.
- Rotate the blade numbered 1 through 180° and fit it into position 4. Rotate the released blade 4 through 180° back into position 1.
- Rotate the blade numbered 2 through 180° and fit it into position 6. Rotate the released blade 6 through 180° back into position 2.
- Rotate the blade numbered 3 through 180° and fit it into position 5. Rotate the released blade 5 through 180° back into position 3.

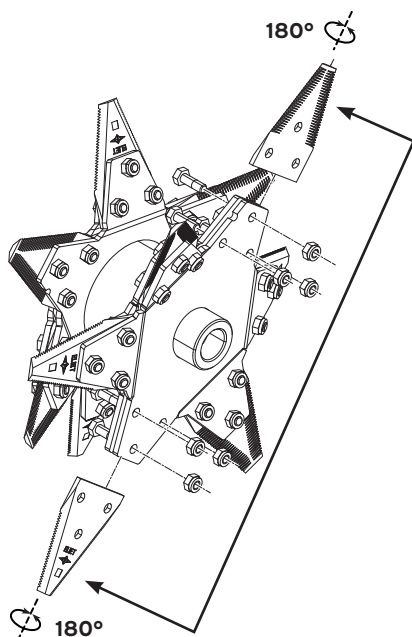

Repeat this procedure for the second blade disc.

- Always make sure to refit the bolts in the blade holders in such a way as to ensure the nuts are on the **tightening side**. This will ensure the direction of rotation to secure the blade shaft against loosening.

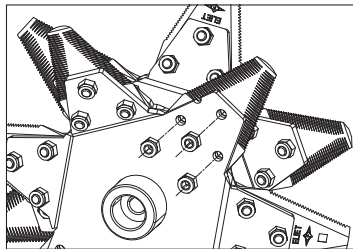

Caution:

After reversing the chipping blades, always check the bolts for correct tightness after expiry of the first 5 hour run. Ignoring this operation may cause serious injury and may even lead to death. The machine may also be significantly damaged.

11.3.4.2 Work method for replacing the blades

New sets of blades are available from your ELIET dealer under the following part number: BU 401 100 102

- Stop the machine and disconnect the power supply extension cable from the machine.



Warning:

The blades may continue to rotate for a few seconds after the motor is switched off. Always check whether the blade shaft has come to a complete standstill before removing the shredding chamber cover.

- Open the shredding chamber (“read § 16.2 Opening and closing the shredding chamber” on page 50).



Warning:

Wear protective gloves as the blades are razor sharp!

- Remove the blade shaft from the machine to replace the blades (see annex 3).
- For safety's sake, firmly clamp the blade shaft (i.e. In-between a bench vice) and ensure that this cannot twist, move or fall unexpectedly during maintenance and, thus, injure someone.
- When replacing the chipping blades, simply remove the old ones and replace them with new items.

You may not simply randomly reinstall the blades. A specific order needs to be respected.

- Number the blade positions on the blade disc from 1 to 6 to ensure mistakes cannot be made. Start numbering with the right blade position that shows a notch and number clockwise (as viewed from the tightening side).
- Next, position the new blades as indicated in the drawing below. Keep the position of sides **F** and **B** in mind.

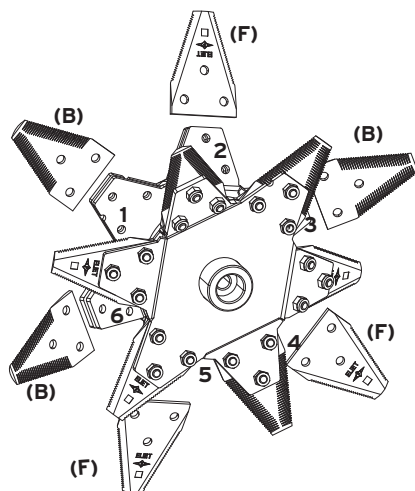
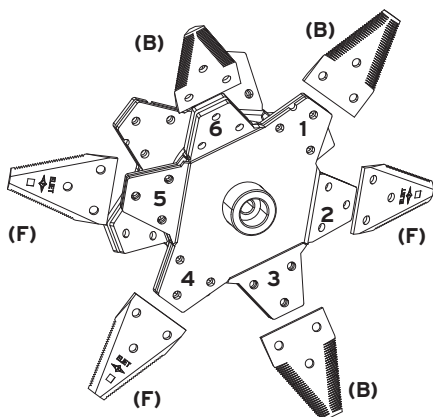
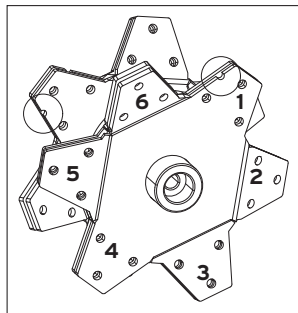

- Before fitting a new blade in between the two blade discs, first remove any dirt that may have built up between both mating discs.

TIP: To do so, use a stripping knife and compressed air.

- Always fit new bolts and nuts when replacing chipping blades. (This will also have been supplied when ordering a blade set.)
- Always make sure to refit the bolts in the blade holders in such a way as to ensure the nuts are on the **tightening side**. This will ensure the direction of rotation to secure the blade shaft against loosening.

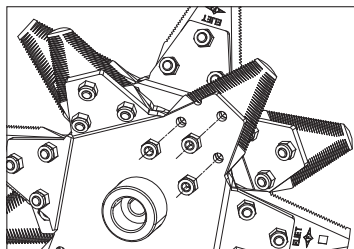

Caution:

Incorrectly or poorly installed blades may lead to breakdowns or damage to the machine. Operators and bystanders are also put at risk.

- Follow the same procedure for the second blade plate.
- Perform a check to verify whether the blades have been installed correctly: Apply the following rules:

1. All blades (2 per blade disc that have been positioned at an angle on the blade disc and are oriented towards the wall of the shredding chamber must always be pointing with their back (**B**) towards this wall.
2. The blades (2 per blade disc) that have been positioned at an angle and are oriented towards the adjacent blade disc must always have their backs (**B**) directed towards the other blade disc.
3. The blades that are in the straight position (2 per blade disc) must alternate between being oriented towards the left and the right.

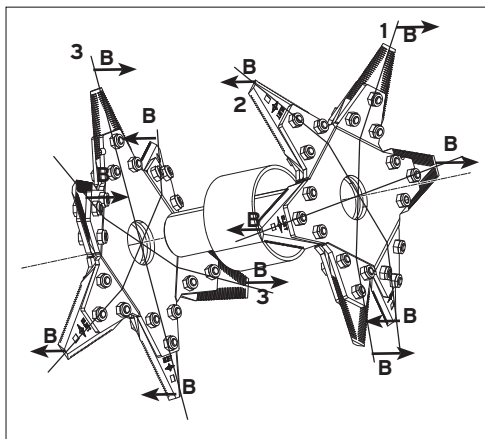

- When refitting the chipping blades check that all bolts are tight.
- Since the large number of retaining bolts, it is a good practice to check the bolts for correct tightness before fitting the blade shaft. Mark a position using a pen on the nut so that you are sure that they have all been tightened.
- The next time you start chipping, consideration should be given that new chipping blades take time to stabilise. This means that the bolts will probably loose tension which, in turn, means that certain blades will again become loose between the plates. **Thus, retighten the blade bolts within the first 5 operating hours of the machine. (Torque loading 10 Nm)**



Caution:

After replacing the chipping blades, always check the bolts for correct tightness after expiry of the first 5 hour run. Failing to do this may have serious consequences for the operator and for the machine.



11.3.5 General lubrication treatment

ELIET is committed to using high-quality materials that extend a machine's life cycle despite the sometimes extreme work circumstances in which chippers are being used. For this reason, special lubrication products have already been applied in the factory.

These parts need lubrication:

1. Wheel axles
2. Conduction of the collecting bag
3. Bearing or blade shaft support ring
4. Bolts for fixation infeed hopper

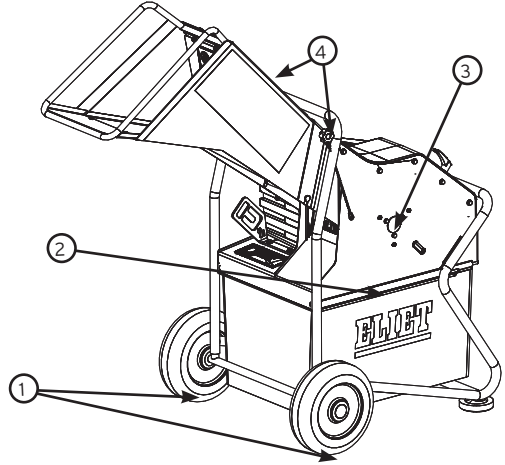

Spray with penetrating oil or a spray based on MoS₂ on the zones to loosen old lubricant and to reduce any corrosion.

Wipe with a cloth all remnants of penetrating oil, dirt and old grease away. Purify everything as much as possible.

Then apply the new lubricant. Preferably use a lubricating spray Teflon (PTFE) based.

12. Winterizing the machine



- Clean the machine (“read § 9.6 Cleaning the Machine” on page 28).
- When storing the machine for long periods, it is recommended to perform the following steps.
- Conduct a major overhaul (“read § 11.2 Maintenance schedule” on page 32).
- Check all nuts and bolts for correct tightness. Checking most bolts for correct tightness simply involves the use of two sets of open-ended spanners (10, 13 and 17) and a set of Allen wrenches 4, 5 and 6.
- Places where the paint coating is damaged are repainted or covered with grease in order to prevent rust. ELIET original paints are available from your ELIET Dealer.
- Store the machine in a dry place that is protected against rain, and if necessary, cover it with a tarpaulin.
- Never keep the machine in a place where it can come into contact with a naked flame source.
- If the machine is to be stored outside, it must be well protected with a tarpaulin.
- Ensure that water does not directly fall onto the machine. ELIET strongly recommend that the machine is stored at a location that is well protected from the weather, etc.

13. Equipment Specifications



	Maestro City
Shreddable timber diameter	35 mm - 1" 3/8 diameter
Chopping speed (cuts/min)	36.000
Capacity (wheelbarrows/h)	10
Blades	12 ELIET Resist™ knives reversible
Infeed height	1050 mm / 41"
Collecting box capacity	60 litres / 16 US gallon
Storage dimensions	740x650x910 mm / 29x26x36"
Dimensions	1360x650x1260 mm/ 54x26x50"
Weight	60 kg / 132 lbs

14. EC Declaration of Conformity

English

Machine: **Shredder**
Model number: **ELIET MAESTRO CITY**
Type: **MA 001 052 912**

This machine has been designed and manufactured to comply with the following European CE regulations:

“EN 13683:Garden Equipment -Integrally powered shredders/chippers -Safety”

ELIET machine factory hereby declares that after performing a hazard analysis, it is fully aware of the potential hazards and risks associated with the machine. In this knowledge, the necessary steps have been taken in line with Machine Directive 2006/42/EG in order to ensure absolute operator safety for the operator, when the machine is used correctly.

The assessment of the sound power level and the guaranteed sound power level as determined in European Directive 2000/14/EG annex III/B 50 was carried out in accordance with the measurement instructions of EN 13683.

Measured sound power level: City: 110 dB(A)
Guaranteed sound power level: City: 110 dB(A)

Date: 01/2018
Signature:



Frederic LIETAER
CEO ELIET EUROPE NV

ELIET EUROPE NV
Diesveldstraat 2
B - 8553 Otegem
Belgium
Tel: +32 56 77 70 88
Fax:+32 56 77 52 13
E-mail: info@eliet.be

15. Warranty conditions

Dear Customer,

Thank you for placing your confidence in ELIET. We are convinced that the appliance you have chosen will fulfil your needs and expectations over the coming years. ELIET is committed to guaranteeing the good performance of its products.

What is warranty ?

ELIET's product design and manufacture procedures are subject to strict quality guidelines, aimed at **guaranteeing** a long product life and permanent safety. To ensure this, ELIET will repair any **hidden defects or abnormalities** throughout the warranty period, provided you **use your machine as instructed**.

Warranty conditions

ELIET's warranty obligations for new machines is governed by the following conditions.

I. Warranty period

The warranty period starts the day the dealer delivers the machine to the customer (date of invoice) and expires

- After two years of private use.
 - After twelve months or 100 running hours* of rental use.
 - After twelve months or 100 running hours* in semi-professional or in professional use.
- To be eligible to obtain warranty the customer is invited to register the newly purchased machine with ELIET. You should complete the registration online on Eliet's website: **www.elieta.eu**

* what is reached first

II. Non-applicability of the warranty

- Wearing parts like knives, bearings, belts, chains, cogwheels, tires, lamps, fuses, etc. are not covered by the warranty.
- When the defect is shown to be caused by improper handling, improper use, negligence or consequential damage that occurs as a result of external influences (fall, broken stones, foreign object, accident).
- When the defect is shown to be caused by a lack of periodic maintenance or cleaning in accordance with the prescribed periodic maintenance.
- If it turns out that the defect was caused by acting against the instructions or advice of the user manual in.
- When the defect occurs after a repair by an unofficial ELIET dealer or a repair using parts that are not original ELIET parts.
- When the defect is shown to be due to the unauthorized modification of the machine's original construction.
- When the defect occurs after use of the machine contravening the instructions for use in the manual.

- When the warranty procedure is not followed or after the end of the warranty term.
- For all problems relating to the motor, please contact an authorized service centre of the engine manufacturer.

III. Procedure

- **Step 1:** On the date of purchase, the customer should register his/her purchase online by completing the registration card at **www.eliyet.eu**.
- **Step 2:** In the event of a defect becoming apparent, the customer shall have this verified by the authorized ELIET dealer. If the dealer feels that there is a factory defect, the dealer may invoke the warranty, under the terms specified.
- **Step 3:** Every warranty application must be accompanied by a fully completed official application form. Copies of this warranty application are available to dealers at ELIET or even at an importer/agent.
- **Step 4:** The dealer then orders the parts needed to perform the repairs. Next, the dealer faxes the order form together with the completed warranty form.
- **Step 5:** The warranty form should be stapled to the purchase invoice and mailed to ELIET or an importer/agent of ELIET.
- **Step 6:** ELIET will send the parts ordered to the dealer under the regular delivery and payment conditions.
- **Step 7:** The defective part will be examined by the technical department first prior to approving or rejecting the warranty. ELIET reserve the right to solely decide whether or not the customer has complied with the conditions for the validity of this warranty, i.e. 1 year or 2 years. Faulty components shall become the property of ELIET.
- **Step 8:** When a warranty claim is found to be valid, ELIET will credit the warranty parts. Customers shall never be entitled to apply for a refund of labour costs.

IV. In case of damage caused by transport

- All goods are supplied ex factory. Transport risks are borne by the customer. It follows, that ELIET highly recommend to check the goods for damage on arrival.
- Any damage found should be stated on the delivery form before signing. Make sure the driver of the haulage company puts his signature next to the damage on your copy.
- In the absence of a written and signed declaration on the delivery form, the insurance of the haulage company will not accept any liability.
- Damages can be claimed from the hauler using a copy of the delivery form and a covering letter stating your complaint.
- The damaged machine should be kept in its original condition until the hauler's insurer has performed any examination.

16. Annexes

16.1 Hazard analysis

Below you will find a list of dangers and risks that are linked to storing away, transporting or using the chipper. Take note of these dangers and avoid these risks by following the instructions contained in this manual. Be aware that it is not just the user who runs a risk but also third parties can be exposed to these risks. Ensure that bystanders are always kept at a safe distance.

- Injury to hands due to reaching into the infeed opening past the anti-projection flaps.
- Danger of suffering heavy injuries or death because a machine part (blades, bolts, etc.) have become loose because there has been a lack of checking and maintenance.
- Danger of suffering injuries due to projection along the feed and discharge sides after a foreign object has been introduced (stone, metal, textile, PVC, etc.).
- Injuries caused by chippings flying out from the discharge opening when the machine is in operation.
- Cutting injuries to hands due to injury from the blade shaft coasting to a stop on opening the shredding chamber.
- Cutting injuries to hands when disassembling the blade shaft.
- Cutting injuries due to the blade shaft falling after being disassembled.
- Strangulation or constriction by loose clothing getting caught in moving parts.
- Injuries caused by the machine tipping due to unsafe transport.
- Danger of suffering burns due to chippings and wood residue that is blocking the cooling air ducts.
- Irritation of the airways or lung problems due to inhaling the dust produced.
- Hearing disorder due to insufficient protection of the ears during the work.
- Bruising or injury when feeding materials, due to the power of the blades on the wood.
- Bruising or injury due to the kick-back of wood when being introduced in the feeding hopper.
- Mental disturbance or rheumatic disorder due to shredding for a long time at a time without taking breaks.
- Joint pain due to vibration transfer when continuously inserting thick branches.
- Injuries following contact with the blades for blockage clearance, maintenance or cleaning the machine.
- Back problems caused by lifting the machine in an irresponsible way..
- Injury due to a fall while driving over a substrate that cannot carry the weight of a person and machine.

This is not a comprehensive list and is provided for information purposes only to safeguard the safety of the user.

16.2 Opening and closing the shredding chamber

16.2.1 Opening the shredding chamber

1. First remove the collecting bag out of the machine to get access to the sieve
2. Turn the lever (1) to loosen the lock on the screen. If the lever is completely loose, press on the handle. This way the screen comes out of its seat and can be taken out of the machine.

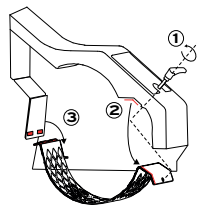

Warning:

The blades are razor sharp, avoid injuries and wear gloves!

3. To get a better view on the situation in the shredding chamber, and to be able to empty the shredding chamber easily, tilt the machine over the front wheels till the funnel rests on the ground.

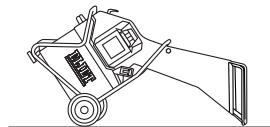

16.2.2 Closing the shredding chamber

In order to remount the screen, slide the two protruding parts in the provided slots on the front of the machine. Then tilt the screen in the shredding chamber and press it against its seat. The screen hooks behind the edge of the chamber wall. Now turn the lever to tighten the sieve again. Turn the lever till sufficient tension is built up.

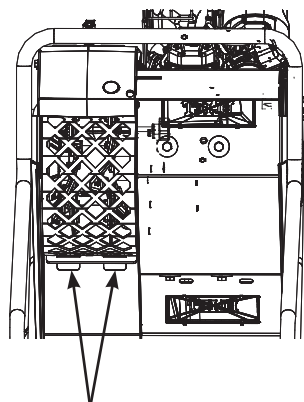

16.3 Removing and reinstalling the blade shaft



Caution:

Always switch off the engine prior to removing the blade shaft.



Warning:

To perform this maintenance, you are exposed to the blades. Protect yourself against the risks and wear safety gloves.

Before removing the blade axle, slide the collecting bag out of the machine and remove the sieve ("read § 16.3 Removing and reinstalling the blade shaft" on page 51)

If necessary, remove the chips from the shredding chamber.

The blade shaft is mounted on the crankshaft of the engine and is thus borne by the engine. In the case of the engine, the suspension of the blade depends on the model:

- In the **Maestro City** the blade shaft is mounted directly on the crankshaft from the engine. On the other side of the blade shaft is a bushing (opposite to the engine side) on the Maestro City. This nylon bushing holds the blade shaft in place when it is under pressure or when it's pushed out of alignment. There is an air gap between the bushing and blade shaft in normal operating position.

To disassemble the blade shaft, first dismount the nylon support ring City). To do this, loosen the three (1) M8 bolts (key size 13) or the three M6 bolts (key size 10).

Remove the rubber protection cap (2) in the right side of the shredding chamber to gain access to the central clamping bolt of the blade shaft. Turn this clamping bolt (key size 17) counterclockwise and remove it from the machine.

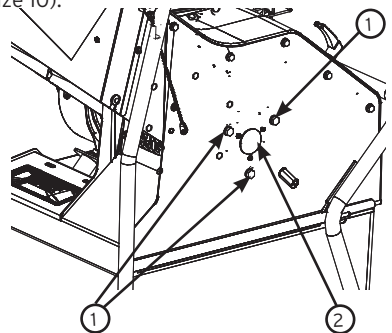

Now you can loosen the engine mounting plate from the frame. To do so, loosen the four M8 bolts completely. The engine and its fixing plate are no longer attached to the chassis.

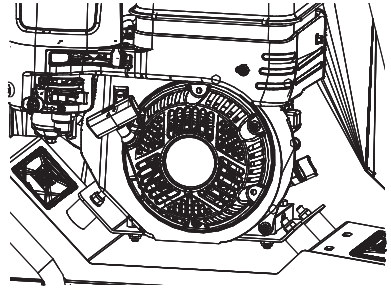

Once the clamping force is gone, you can slide the blade axle from the crankshaft. Grab the blade axle between two blade plates at its core, and hold it up. Now slide the engine away to the left, so that the crankshaft is completely out of the hub of the blade axle.

Remove the blade axle from the machine by the output zone

Check if the nylon support ring doesn't show any signs of wear. Replace it if needed: Item number: MPA 01 221 470 .

When reassembling the blade shaft be ensured that the nylon support ring is already mounted on the shaft end of the blade shaft before reinserting it in the shredding chamber.

Now slide the crankshaft of the engine in the hub of the blade shaft until it is clamped on the tapered shaft. Tighten the clamp bolt back in to the central part at the end of the blade shaft. Tighten this clamp bolt securely (wrench 13).

Now reassemble the nylon support ring and screw it tight. Caution: Do not put too much tension on the screws so that the screw thread doesn't tear.

Place the rubber cover back into the opening.

Now shift the engine so that the blade shaft is central in the shredding room, and the distance between the two outer knives is equal on both sides.

Place the clamping bolts back in the engine plate. Turn the bolts till the moment where there is no tension on the bolts. Now, see if the blade shaft is aligned relative to the Central nylon support block. The air gap between the blade shaft and nylon support block must be equal everywhere. If not, rotate the engine a little to adjust this. Now you tighten the fixing bolts of the engine securely.

16.4 Dismantling the infeed hopper

For easy transporting of the machine in a car or other vehicle, the feed hopper can be dismantled.

Screw both screws bolts out of each side of the hopper, first screw out the left bolt, afterwards the right one.

The engine should be turned off for this maintenance. Once the screws are gone, the funnel can be removed. Support the hopper with you right hand, while lifting the hopper out of its position with your left hand.

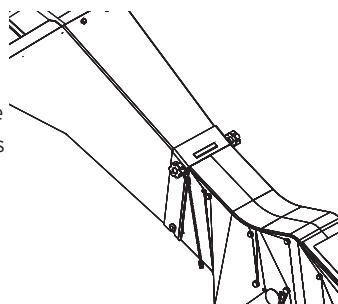

Caution:

Be careful when putting the hopper on the ground. Don't drop it. This could severely deform the hopper, making it no longer fit correctly on the machine.

