

ELLIET®

MANUAL

E 501



This manual contains practical information about the use and maintenance of your machine. Read it carefully and keep it safely for future reference.



Please also keep your purchasing invoice or receipt together with this booklet.



Register your product online on www.eli.eu

© ELIET

Copyright 2008 ELIET. All rights reserved. The texts, images and other information in this manual are protected by copyright and also by other intellectual property rights. Therefore, nothing from this manual may be used for commercial or other purposes. Certain parts in this manual are also protected by copyright owned by Eliet suppliers.

1. Introduction



1.1 Read this operating manual carefully

ELIET machines are designed for safe and reliable use if they are operated in accordance with the instructions provided. Carefully read these operating instructions before using the machine. Failure to do so may result in personal injury or damage to the equipment.

1.2 Identification data - ELIET E501 Scarifier

Note the identification data relating to your machine in the text boxes:

Type number:

MA

Engine :

Serial number :

Year of manufacture:

20

2. Warranty



2.1 Warranty card

To be eligible to obtain warranty you must send the completed warranty card within one month from the date of purchase to the address stated below:

European customers:

ELIET EUROPE NV

Diesveldstraat 2

B-8553 Otegem

Ph (+32)(0)56 77 70 88 - **Fax** (+32)(0)56 77 52 13

E-mail: service@eliet.eu, www.eliet.eu

US customers :

ELIET USA Inc.

3361 Stafford street (office B)

15204 Pittsburgh (PA)

Ph (+001) 412 367 5185 - **Fax** (+001)412 774 1970

e-mail: usinfo@elietusa.com, www.elietusa.com

Read the warranty conditions on the attached warranty card.

3. Welcome



Welcome to the family of ELIET users.

We thank you for the trust that you have placed in ELIET and we are convinced that you have purchased the very best machine. The operating life of your ELIET machine depends to a great extent on how you care for your machine. This manual and the engine manual included will help you on your way. If you follow the instructions and suggestions in these manuals, your ELIET machine will operate for a very long time in optimal condition. Read this manual carefully before operating the machine. This will prevent you from operating the device incorrectly. For your own safety, please observe the safety instructions specified in the relevant chapter. Even if you are thoroughly familiar with operating such equipment, it is still advisable to read these pages carefully. All ELIET equipment and machines are continually being updated and improved and therefore the specification of your machine may differ slightly in terms of shape, technology and accessories. The descriptions and technical data in this manual are accurate at the time of printing. Certain illustrations and descriptions may not be applicable to your specific machine, but instead relate to a different version of the machine. In turn, we trust that you will understand that the texts and illustrations in this manual cannot give rise to any claims. If you still have questions after you have read this manual, please contact your ELIET dealer. Find an authorised ELIET dealer near you on **www.elieta.eu**.

ELIET AT YOUR SERVICE

During office hours ELIET's help desk will make every effort to answer all of your questions:

European customers :

GMT +1: van 8.00 u tot 18.00 u

Tel: +32 56 77 70 88

Fax: +32 56 77 52 13

service@elieta.be

US customers :

Ph (+001) 412 367 5185

Fax (+001) 412 774 1970

usinfo@elietusa.com

www.elietausa.com

4. Table of Contents

1. Introduction	3
1.1 Read this operating manual carefully	3
1.2 Identification data - E501 Scarifier	3
2. Warranty	3
2.1 Warranty card	3
3. Welcome	4
4. Table of Contents	5
5. Operator safety warnings	6
5.1 For your information	6
5.2 Caution	6
5.3 Warning	6
6. Main parts	7
6.1 Overall view	7
6.2 Engines	8
7. Safety instructions	9
7.1 Safety messages	9
7.2 Safety features	11
7.3 Safety instructions	12
8. Dealer's duties	15
8.1 Unpacking the machine	15
8.2 Positioning the handlebar	16
8.3 Other duties	16
9. Operating instructions	18
9.1 Preliminary checks	18
9.2 Refuelling	18
9.3 Preparing the work site	19
9.4 Starting the engine	20
9.5 Operating the machine	20
9.6 Stopping the engine	22
9.7 After finishing the work	23
9.8 Lawn treatment after dethatching	24
10. Transporting the machine	25
11. Maintenance	26
11.1 General	26
11.2 Maintenance schedule	27
11.3 Lubricants	27
11.4 Routine checks before each operation	27
11.5 Maintenance after 20 hours of operation	31
12. Storing the machine	39
13. Specifications	40
14. EC Declaration of Conformity	41
15. Warranty conditions	42

5. Operator safety warnings

ELIET cannot anticipate every situation in which a risk or danger can occur. The warnings in this operating manual and the labels on the machine are therefore not comprehensive. Even though this will be minimal, a residual risk will always be present. If you apply a working method, operation or technique as the operator of the machine that is not explicitly recommended by ELIET, ensure in any case that this will not present a danger for bystanders.



A number of symbols ("For your information", "Caution", "Warning") are used in this operating manual to provide additional information and to highlight dangers..

5.1 For your information



For your information :

This symbol is used to draw your attention to specific information and/or actions, or to indicate where you can find additional information relating to the subject.

5.2 Caution



Caution:

This notice identifies safe practices in order to prevent incorrect operation that may result in personal injury or damage to the machine.

5.3 Warning



Warning :

This notice warns you about extreme danger that you must be aware of in these specific circumstances.

So remain alert, in order to ensure your own safety.

These safety messages can only warn and not remove the danger.

Using common sense and observing the guidelines contained in this manual are essential to prevent accidents.

6. Main parts



To fully understand the content of this operating manual you need to be fully conversant with the terminology used for the descriptions. In this chapter you can find a set of parts identified by name. It is a good idea to take time to study the machine beforehand for a better understanding of the descriptions provided in this operating manual.

6.1 Overall view



- | | |
|---|-------------------|
| 1. Handlebar | knobs |
| 2. Operation handle | 6. Mud flap |
| 3. Engine | 7. Wheel scrapers |
| 4. Belt protection cover | |
| 5. Continuous - stepless - height control | |

6.2 Engines



Honda GC160 5pk

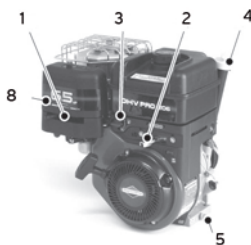

Briggs & Stratton 6,5pk



Honda GX160 5,5pk

1. Choke
2. Speed control
3. ON/OFF switch
4. Oil filler cap/dip stick
5. Oil drain plug
6. Fuel tap

7. Exhaust
8. Air filter
9. Fuel filler cap
10. Condenser
11. Overflow protection device



For your information:

All references to front, rear/back, left and right in this manual are from the viewpoint of the operator standing behind the machine and facing the direction the machine is travelling.



For your information:

Your ELIET dealer remains at your service for any maintenance or advice, ensuring your ELIET machine is always in perfect condition. You can contact him for original ELIET parts and lubricants at any time. These service parts are manufactured according to the same strict rules and craftsmanship as the original equipment.



Caution:

For your own safety, only original parts may be mounted on ELIET machines.

7. Safety instructions



7.1 Safety messages

The safety messages are clearly indicated on the machine with stickers or relief pictograms.

Sticker = Danger!



This sticker is affixed on the belt protection cover and warns about the danger of hand injuries. Keep your hands and feet away from underneath the machine as long as the blades are rotating. The engine must be turned off in case of faulty operation or before starting maintenance.

Item no. BQ 505 010 070

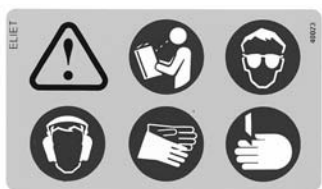

This sticker is affixed on the machine near the engine. This sticker provides a summary of the general safety regulations by using icons:

1. Before operating the machine the manual should be read and understood.
2. Suitable safety clothing (gloves, safety goggles, ear defenders) should be worn when operating the machine.
3. Working with or performing maintenance on the machine poses the risk of slicing wounds to the hands. Remain alert and cautious.

Item no. BQ 505 010 050



This sticker is affixed on the machine near the engine. This sticker points out to the operator that the engine must be turned off and the spark plug cap must be removed before starting maintenance on the machine.

Art nr : BQ 505 010 040

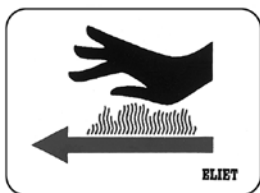

This sticker is affixed near the exhaust and warns the operator for hot surfaces with a high risk of burns.
Item no. BQ 505 010 060

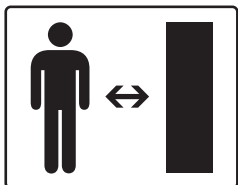

This sticker is affixed next to the engine. It reminds the operator to keep bystanders at a distance while operating the machine.
Item no. BQ 505 010 150



This sticker is affixed on the cover of the driving belt. It indicates the potential danger arising when the cover is removed while the engine is running. The machine may never be operated without the cover. The engine must be switched off before removing the cover at all times.
Item no. BQ 505 010 130

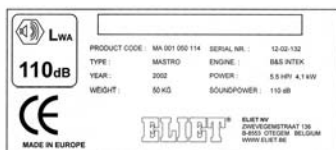

This unique sticker contains all machine identification data.

- Year of manufacture
- Model
- Type number
- Serial number
- Capacity
- Weight
- Guaranteed A-weighted noise level

In addition, the sticker bears the manufacturer's company information. The sticker bears the seal of conformity with European standards in the form of a CE label.



Caution:

If due to cleaning or use, safety stickers or parts displaying safety information have been damaged, removed or become illegible, they must be replaced immediately. Stickers and parts can be obtained from any authorised ELIET dealer.

7.2 Safety features



Operation handle: Releasing the operation handle disengages the blade drive from the engine, causing the blade axle to come to a stop.



Steel compartment and mud flap: The blades are encapsulated in a firm steel compartment; together with the mud flap it stops moss, grass and pebbles from flying up.



Belt protection cover: The cover ensures that all rotating parts of the driver that might cause injuries are adequately screened off.



Lateral blade guard: A screen between the wheels protects the operator's feet against lateral contact with the rotating blades.



Warning :

Never attempt to circumvent or disengage safety devices.

Safety measures were designed for your safety.

Before using the machine, the operator should check that the safety device works properly.

Any defects must be repaired prior to using the machine.

7.3 Safety instructions

7.3.1 General safety regulations



Warning:

MOST ACCIDENTS ARE CAUSED BY CARELESSNESS OR RECKLESS BEHAVIOUR.

- The owner of the machine will keep this manual during its complete service life. A reference guide for the user, it also ensures that the machine is used and maintained correctly at all times. Always refer to this instruction manual if you have any doubts about an operation that you are about to perform.
- If the instructions stated in this manual are not clear to you, do not hesitate to contact your Eliet dealer for further explanation. In addition, the ELIET help desk is at your service during office hours to answer any questions you may have (EU +32 56 77 70 88).



For your information:

Also read the engine manual supplied with your machine. It contains useful tips about proper use and maintenance of the engine.

- Read the chapter meant for the dealer (see § 8; page 16) and verify whether the machine has been delivered in accordance with the instructions.
- Carefully observe all safety instructions when using this ELIET machine. Make sure to read all the instructions about how to operate the machine. All these instructions are for your own safety.
- Get advice from the dealer or another professional when purchasing the machine.
- Read and observe all safety messages stickered on the machine.
- Always observe the applicable regulations of the Labour Inspectorate to avoid accidents.
- Under no conditions whatsoever may the original design of the machine be modified without explicit and written consent of ELIET EUROPE NV (Belgium).

7.3.2 Careful and proper use

- Think about what you are doing whenever you operate the machine. Do not be tempted to let routine dull your attention. Never act impulsively or on reflex.
- Despite the extensive safety features, do not seek out dangerous situations.
- This machine serves to loosen and remove the moss and felt growing on the bottom layer of your lawn and must be used for this purpose only.
- Dethatching is a surface operation. The blades should only touch the upper surface. The maximum blade depth is 2 millimetres. Too deep a blade setting increases the risk of broken blades and increased wear.

ELIET accepts no liability for damage resulting from improper blade settings.

- Dethatching must only be done in a forward travelling direction. In view of general safety, ELIET advises against dethatching in a backward direction.
- Never dethatch when the ground is frozen.
- It is recommended to work a dry lawn. Wet lawns increase the risk of accidents; extra care is necessary under these circumstances.
- If the lawn is too dehydrated after a period of drought, dethatching is not recommended. The dust generated from the lawn would increase wear of the machine. In addition, dethatching would have a negative effect on the lawn.
- Never work when light intensity is below 500 Lux.
- The machine may never be used as a means of transport for people or loads.
- Make a thorough inspection of the area where the machine is to be used. Remove sticks, stones, wires and debris, but also take account of electric cables, water pipes, sprinkler heads, drain covers, etc.
- The blades must be disengaged as soon as the machine is taken off the lawn and pushed across a hard surface. When crossing larger distances on a hard surface, the engine must be turned off as well.
- Use the machine in an environmentally safe manner:
 - Avoid running the machine without actively using it.
 - Avoid spilling petrol while refuelling.
 - Service the engine regularly in order to maintain optimum combustion.

7.3.3 Operator's responsibilities

- All persons using the machine are assumed to be fully conversant with the safety instructions. **The operator has full liability for the use of the machine with regard to himself and third parties.**
- The operator of this machine is assumed mature enough and with enough common sense to make decisions by himself.
- The machine may not be operated by underage persons. This does not apply to youths over 16 who are learning to operate the machine under the supervision of an experienced operator. This manual must be read before use.
- Children (under 16 years of age) and animals should be kept at a safe distance (10 m) from the machine.
- ELIET advises against lending the machine to others, but if this should occur, it should only be lent to persons who are familiar it. **Always point out the potential hazards to the user and ensure that they have read the manual before using machine.**



Warning:

A MOMENT OF INATTENTIVENESS OR CARELESSNESS CAN LEAD TO LIFE LONG REGRET.

7.3.4 Personal Protective Equipment (PPE)



For your information:

Personal protection equipment reduces the risk run by the operator.

- Suitable clothing must be worn when operating this machine, i.e. clothing covering the entire body, protective gloves and closed footwear.
- Since your feet run a high risk when operating the machine, sturdy, closed non-slip shoes are a must. Shoes with a steel top are highly recommended.
- For protection of the most sensitive senses, ELIET recommends hearing protection and safety goggles.
- Dethatching can produce a considerable amount of dust. If it irritates your respiratory airways, ELIET recommends you wear a dust mask (in compliance with the 89/686/EEC standard).

7.3.5 Danger zone

The safe position for the operator is behind the machine, with both hands on the handlebar.

- Never allow bystanders within the danger zone stretching up to 10 m around the machine during work.
- Do not take risks! Stop the blade drive as soon as someone enters the danger zone.
- Shut off the engine when leaving the machine unattended.
- Once the motor is running, focus all your attention on operating the machine.

7.3.6 Periodic maintenance



For your information:

For your own safety, and in the interest of preserving the life of the machine, this machine should undergo regular maintenance.

- Periodic maintenance is essential. Strictly follow the maintenance schedule included in this operating manual (see § 11.2; page 27). A maintenance meter helps you keep track of the machine's hours of operation.
- When parts require replacement as a result of wear or defect, always request original ELIET replacement parts from your ELIET dealer. This is of key importance for your own safety. (find an authorised ELIET dealer near you on www.elieta.eu)
- Since wearing hearing protection can impair the ability to hear warning sounds (such as yelling, signal tones, etc.), increased alertness is required under those circumstances.
- ELIET advises against the use of a Walkman or a portable MP3 player while operating the machine.
- Repairs, maintenance and cleaning must only be performed with the engine disengaged and the spark plug cap decoupled.

8. Dealer's duties

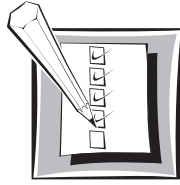

8.1 Unpacking the machine

- ELIET machines are packaged in accordance with common rules for proper transportation. Deliveries are always ex factory. ELIET cannot, therefore, be held liable for any damage occurred during transport.
- If the packaging is damaged upon receipt of the goods, check the state of the machine to ensure it is not damaged. Report any irregularity on the delivery order before signing for receipt.
- In case of damage to the machine a complaint to the shipping company must be submitted immediately after delivery.

- Set the box on an even surface. Pay attention to the arrows indicating the upper side of the box.
- Cut open the side of the box and pull out the flaps.



- Pull the machine from the box.

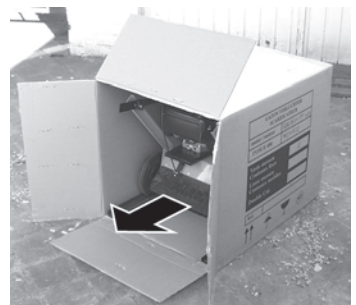

8.2 Positioning the handlebar

- Push the handlebar back from its horizontal position until it clicks into its guide.

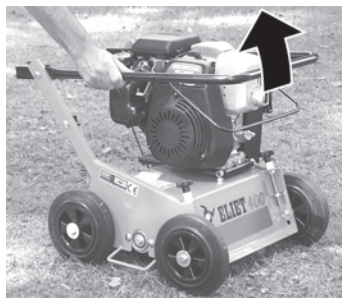

- Secure the nuts on either side of the handlebar.



8.3 Other duties



Warning:

As an ELIET dealer you **must** familiarize your customers with the **operation of the machine** and also **point out the possible dangers** while using it. You are expected to carefully go over the maintenance points of the machine together with the new owner. Repeat these instructions until the new owner has fully understood everything.



Warning:

In its position as a manufacturer, ELIET wishes to re-emphasise that the dealer must expressly point out to the customers that they must re-tighten all bolts of the machine **within the first 5 operating hours**.

- The fuel tank will be filled (see § 9.2; page 18)
- Prior to delivery to the customer, the dealer will check the oil level by means of the dipstick.

- The dealer checks that the RPM setting is at 3200 RPM.
- The dealer makes a final test drive and checks that all devices operate properly.
- The dealer checks that all safety features work perfectly.
- Every Eliet dealer warrants a long life span of Eliet machines. He will lubricate the hinges before delivering the machine to the client.
- Important information for the new owner at the time of delivery:
- The dealer familiarizes the new owner with the machine's operation.
- The dealer informs the new owner of potential dangers.
- The dealer insists that the machine be returned for first maintenance after 10 hours of service (belt tightening and first oil change are required).

**Caution:**

The dealer ensures that the warranty card is filled out and signed for reasons of avoiding warranty disputes. Please read the warranty conditions for more details.

9. Operating instructions

9.1 Preliminary checks



Caution:

Try making a habit of checking the following points before getting to work with the machine:

Checklist

- Check the machine's hours of operation and compare this number with the maintenance table (see § 11.2; page 27).
- Check the oil level. Pull out the dipstick and check whether the oil level is below minimum (see § 11.4.2, page 28).
- Check that the fuel tank is full. If not, fill it up (see § 9.2; page 18)
- Check the air filter for excessive dirt (see § 11.4.3, page 32).
- Check the blades for wear (see § 11.5.6, page 33).
- Check that the belt tension is adequate (see § 11.4.5, page 32). If not, adjust it (see § 11.5.5, page 33).
- Check that the depth setting is correct (see § 11.4.4, page 33).
- Check that all protection covers are present and properly in place.
- Check that all safety provisions on the machine are still operating properly.
- If the machine is equipped with a maintenance meter, check that it operates at the indicated speed (3200 RPM). Never attempt to change the default engine settings.

After verification and approval of all points on the checklist, the work area can be prepared (see § 9.3, page 19) and the machine wheeled to it.

9.2 Refuelling

When petrol in the machine is running low, it must be refuelled. The use of fresh petrol is recommended at all times. Use unleaded petrol, preferably with an octane index of 98 or 99.



Warning:

Under certain conditions, petrol is extremely flammable and highly explosive. Fire breakouts and petrol explosion can inflict severe burns and cause damage to personal property. As a result, please observe the following points:

- Never refuel with the engine running. Always allow the engine to cool down for several minutes prior to refuelling.
- Use fresh petrol only. ELIET is environmentally conscious and therefore recommends using unleaded petrol. Additives may be used for extended fuel freshness.

- Store petrol in an approved tank. Keep out of reach of children.
- Never refuel at the location where the machine will be operated. Keep a distance of at least 10 m from the selected work area in view of fire hazard.
- Never refuel in a closed area.
- Clean the area around the fuel cap and remove it. Don't fill the tank completely. Fill up to approximately 10 millimetres from the brim. So don't fill it up to the brim.
- Always use a funnel or a spout for refuelling. Special funnels are available from your ELIET dealer.
- Put the cap back on the fuel tank as quickly as possible. Immediately clean up any petrol spilled whilst refuelling.
- Also make sure that clothing does not come in contact with the petrol. Should this occur, the clothing must be changed immediately.
- It is irresponsible and therefore strictly forbidden to refill the tank around people who are smoking or near open fire.
- If fuel is swallowed or comes in contact with the eyes, consult a doctor immediately.

9.3 Preparing the work site

- Never work when light intensity is below 500 Lux.
- Besides the machine, the work area must comply with certain conditions also; they must be verified prior to starting the work.
- Examine the work area and remove any foreign objects from the lawn.
- Foreign objects include: metal, stone, plastic, pvc, bones, rope; but also molehills, branches, water hoses, etc. Some of these can cause severe damage to your machine or lead to blade breakage.
- Foreign objects that cannot be removed (such as drain covers, built-in power outlets, water sprinklers, tree roots) must be visibly marked.
- Always cut the grass before dethatching. Ensure that the grass is shorter than 30 millimetres.
- A mowed lawn also displays any foreign objects.
- Dethatching a wet lawn is not recommended.
- Plan your course thus that the wind blows the dust produced by dethatching away from the engine.
- Use of the machine on severely dry soil is not recommended for the following reasons:
 - The grass will recover much slower than usual.
 - The lawn will be badly damaged.
 - The blades wear faster and require replacement sooner.
 - More dust will be produced, soiling the engine more quickly.
 - Greater dehydration of the soil than was the case already.
- We strongly recommend to treat the grass with an anti-moss herbicide or a weed killer approximately 1 week prior to dethatching so as to ensure that the moss is dead and dry. It will help the grass to thicken more easily after dethatching.

9.4 Starting the engine



Caution:

Never start the machine when dust has settled on the engine or between its cooling fins. It reduces proper cooling of the engine and can cause a fire.



Warning:

The blade axle spins as soon as the engine engages and the operation handle is pulled towards the handlebar. Make sure that the operation handle is not pressed when starting the engine. If ever control over the machine's operation is lost, the quickest way to stop the blade axle is by releasing the operation handle.

9.4.1 Petrol engine



For your information:

The procedure to start the engine can vary per brand. Please check your engine manual.

§ 6 "Key parts" contains the various models.

If this has not been done when going through the checklist, always check the engine for adequate oil and fuel levels before starting it.

- Please see § 11.4.2 for details about how to check and refill the oil.
- For petrol refuelling please refer to § 9.2 (page 18).
- If the fuel tank is equipped with a fuel tap, open it.
- Depending on the type of engine, put the handle or turn the switch into the ON position.
- Set the choke handle to "Close".
- Open full throttle, represented by the image of a hare.



Warning:

For optimum protection of your hearing, please put on the supplied hearing protection prior to starting the engine.

Engage the engine by firmly pulling the starter cord.

- The engine running, set the choke handle to "Open". This prevents the engine from getting too much fuel. Should this be forgotten, the engine will slow down and start to smoke heavily, and eventually come to a stop. Restart the engine without opening the choke if this happens.
- Failure to restart the engine points to a greased spark plug which consequently requires clean-

ing or replacing (see 11.5.2 Checking/replacing spark plug).

9.5 Operating the machine



Caution:

As long as the operation handle is engaged and the engine has not come to a full stop after turning it off, the blades will continue to spin. Don't perform any maintenance activities before they have come to a halt.



Warning:

The mud flap and the belt protection cover offer protection against rotating parts. It is therefore prohibited to reach behind these covers with any body parts while the engine is running.

9.5.1 Prior to starting the work

Pay attention to the following safety instructions before starting to operate the machine.

- Never run a petrol engine in a closed environment in view of the risk of carbon monoxide poisoning from the exhaust.
- The operator must wear clothing, protective gloves and other protective attributes as prescribed in this manual (see § 7.3).
- The operator must be alert while he's working. As long as he is operating the machine, his full attention must be on the job.
- Never work when light intensity is below 500 Lux.
- A good gardener works efficiently and according to a well defined plan. It allows him to keep an overview of his work and prevents accidents or wrong manoeuvres with the machine.
- Once the engine is running, it is recommended to allow it to warm up for best performance.



Warning:

Never tilt the machine forward over the front wheels as this may inadvertently engage the blades.

9.5.2 During work

For dethatching, the following procedure must be followed:

- Always place the machine on the lawn before engaging the blades.
- Push the handlebar down slightly to lift the blades from the surface, approximately 3 to 4 centimetres.
- Pull the operating handle against the handlebar to engage the blades.

- Allow the engine to acquire the proper speed.
- Lower the blades.
- Push the machine at medium speed. The slower the dethatching process, the better the result.

Key issues with regard to dethatching are:

- Avoid standing still with the machine as this can cause deep marks in the lawn.
- Efficient dethatching involves two runs of the entire surface, the second one perpendicular to the first.
- Be advised that dethatching is not the same as cultivating. Both processes have their own specific purpose and are carried out with a specific machine.
- Cease the operation immediately when you hear unfamiliar noises. Stop the engine and examine the cause of the noise. Perform any necessary repairs before continuing.
- Should any foreign objects have landed under the machine despite proper preparations, immediately switch off the machine. Remove the foreign object and check for damage. Any defects must be repaired before reassuming operation.

Follow the procedure below to change direction or to cross small distances (paths or terraces):

- Release the operation handle.
- Push the handlebar down slightly to lift the blades approximately 3 to 4 centimetres from the surface. When the blades are still, the machine can be lifted a little higher if necessary.
- Roll the machine to where dethatching must take place.
- Pull the operation handle against the handlebar to engage the blades.
- Allow the engine to acquire the proper speed.
- Lower the blades.
- Push the machine at medium speed.



Caution:

The blades must be switched off before crossing a paved surface. Lift the front wheels approx. 4 cm by pushing the handlebar down. To cross relatively large distances (> 10 m) over a paved surface the engine must be turned off.

9.6 Stopping the engine

9.6.1 Petrol engine

- To stop the engine, switch the throttle or turn the knob into the "OFF" position.
- If the machine is equipped with a fuel tap, close it.

9.7 After finishing the work

9.7.1 Cleaning the machine

ELIET recommends cleaning the machine after each use. We recommend performing an inspection each time you clean the machine to check component and machine integrity. It allows timely intervention and prevention of any defects, ensuring a longer service life of your machine.

Failure to clean the machine can cause:

- increased wear of the bearings.
- Increased wear of covers.
- Reduced motor cooling.
- Increased risk of fire.
- Inability to notice cracks or tears.
- Damage to the paint.
- Illegibility of safety stickers.

Note: Failure to perform the daily [sic] cleanup will result in loss of warranty.

The following points require special attention:

- The engine should be clear of dust and dirt. More in particular the cooling fins and the area around the exhaust must be clean. The area around the fuel cap must be kept clean to avoid dirt entering the fuel tank.
- The bushings must be cleaned from sand and dirt that got stuck in the lubricating grease. Reapply lubricating grease after wiping the bushings (see the list of lubricants in § 11.3).
- Use a dry cloth to remove dirt from the chassis and more specifically from the stickers with safety instructions.



Caution:

Wear suitable clothing for cleaning activities. Utility gloves are essential.

- Use a dry cloth or soft brush for any cleaning. Use penetrating oil with MoS₂ to remove grease and lubricants. It is a lubricant and rust solvent at the same time.
- A steamer may be used for cleaning, but the water should not be overly pointed at bearings, protection covers and filler caps. Water is the number one cause of rust and this must be avoided at all times. Allow the engine to cool down properly before treating it with water.

Any necessary replacement and/or repair works must be undertaken immediately. Visit your authorised ELIET dealer to have them carried out (find an authorised ELIET dealer near you on www.eli.eu).

9.8 Lawn treatment after dethatching

- After dethatching it is essential to thoroughly remove the raked moss to avoid it from reattaching to the soil.
- **Sowing:** To thicken up the lawn after dethatching, new grass must be sown in the open spaces. Working the seed into the soil has preference over sowing on top of the existing grass. It allows faster germination of the seed and quicker thickening of the lawn. Watering the lawn at regular intervals is required. The sowing machine from ELIET's product range is highly suitable for renovating your lawn.
- **Fertilising:** A balanced fertilising treatment is recommended to help recovery of the existing lawn. It also stimulates growth of the sown grass. The choice of fertiliser depends on the soil, acidity and type of grass. Ask advice from a supplier of fertilising products.
- **Aeration:** Very often the soil under the lawn has been pressed together from walking or driving on it. The grass doesn't get enough air as a result. It also prevents easy drainage of rain water and fertilisers. These are causes for slow growth of the grass and increased growth of surface parasites such as moss. Opening up the soil requires aeration at a deeper level.
- **Sanding:** Sanding the lawn can help to provide air to the top layer. Sanding can best be done after dethatching or aeration. Sharp sand is the best choice.
- **Irrigation:** Protecting itself from drought, grass will slow down its own growth during continuous sunny weather and high temperatures. Regular watering is recommended if a period of drought starts after dethatching. A humid soil below the grass is of key importance for absorption of fertilisers, continued growth and recovery of the lawn.

10. Transporting the machine



- To move the machine, push the handlebar down slightly to lift the blades from the surface.
- The engine must be turned off if the machine is moved for transport.
- Only adults are permitted to move or transport the machine.
- During transport children, unauthorised people or animals must not be allowed within a 3 m radius of the machine.
- Carefully choose a clear and free transport path, preferably one with as few obstructions as possible. The transport path should preferably be flat, with an even surface.
- If the machine topples over for some reason, set it upright as quickly as possible. It prevents oil from the crankcase entering the air filter.
- Use non-slip planks for loading the machine into a van or onto a trailer. Ensure that the planks are properly fastened to the vehicle or trailer. Under no circumstances should the upwards slope exceed 25°.
- Attention and care while loading and offloading the machine can prevent it from tipping over and causing an accident.

Mount the planks in a forward direction.

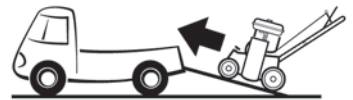

Descend the planks in a forward direction.



- Make sure the machine is properly attached in the vehicle during transport. Use the fixed chassis parts for attaching the ropes.
- The handlebar of the machine folds down for more compact transport. Loosen both nuts on either side of the handlebar; slightly push the arms inwards and fold the handlebar forwards (see § 8.2 page 17, in reversed order).

11. Maintenance



11.1 General

ELIET recommends that the machine be brought to an official ELIET dealer for a major overhaul each year (find an authorised ELIET dealer near you on www.elieta.eu). Your ELIET dealer is at your service for maintenance and advice at all times. Your dealer will stock original ELIET replacement parts and lubricants. His staff can always obtain advice and service from ELIET's help desk in order to provide you with an impeccable after-sales service.



Caution:

Only use original ELIET replacement parts. These service parts are manufactured according to the same strict quality requirements and craftsmanship as the original equipment. For a list of original replacement parts and their ordering codes please visit www.elieta.eu.

Perform maintenance in a room intended for this purpose. This room must be:

- Spacious
- Dust-free
- Easily accessible
- Clean and tidy
- Well lit
- Quiet

These characteristics are important to properly carry out maintenance works.



Caution:

Maintenance performed in an incorrect manner may compromise the operator's safety. Maintenance should be always carried out with the engine turned off. As a precaution, the spark plug should also be removed or the lead detached. Always wear safety gloves when performing maintenance. Safety goggles may be required for certain operations.

11.2 Periodic maintenance schedule

A. Routine check before each operation

- Visual check of the state of the machine
- Oil level check
- Cleaning the air filter
- Checking and setting the depth control
- Belt tension check
- Cleaning the machine (9.7.1 'Cleaning the machine')

B. Maintenance after every 20 hours of operation

- Daily maintenance
- Changing the oil
- Checking and/or changing the spark plug
- Changing the air filter
- General lubrication treatment
- Belt tension adjustment
- Changing the blades

11.3 Lubricants

Engine (0.75 l)	SUNOCO SUPER DENALUBE - SAE 20 W 50 API SF / CC
Hinges	NOVATIO PTFE OIL

11.4 Routine check before each operation

11.4.1 Visual check

Check that the parts are not deformed, that welded seams are not cracked, and that parts do not exhibit excess play. If problems are found, carry out the necessary repairs first.

11.4.2 Oil level check.

Refer to the 'General Description' under '§ 6. Key parts' for dipstick positions and oil drainage and drain plugs.

- Take a clean cloth.
- Pull the dipstick from the filler opening.
- The oil level will usually be hard to read immediately. Wipe the dipstick with your clean towel and re-insert it without fastening it.
- After pulling it out again you will get an accurate reading of the oil level.
- The oil sticking to the dipstick should be between the minimum and maximum mark.

If the oil level is too low, it can be filled via the oil filler. Use only recommended oil. Don't add too much oil at once and check the oil level regularly.

11.4.3 Cleaning the air filter

- The type of air filter depends on the engine brand and type.
- The air filter is located under the black protection cover next to the fuel reservoir on the engine.
- Loosen the black protection cover.
- There are two types of filters: the common sponge filter and a paper filter, similar to that of an automobile.
-

Sponge filters can be cleaned by rinsing them with some petrol and blowing them with compressed air.

- Paper filters are cleaned by dusting them down or treating them with compressed air.
- After cleaning, replace all parts in their original positions.



Caution:

In the event the machine has toppled over for some reason, check the air filter immediately. The unusual position of the engine may have caused oil to seep from the crankcase via the carburettor onto the air filter. Oil on the filter paper obstructs the air passage. Soiled filters must be replaced immediately.

11.4.4 Checking and setting the depth control

CORRECT DEPTH SETTING = MAXIMUM EFFICIENCY



Caution:

This maintenance may only be carried out with the engine off and the blades at full stop.



Warning:

Wear gloves to perform this procedure.

Depth adjustment is carried out by positioning the front wheels (continuous - stepless -) and the rear wheels (2 positions) of the scarifier.

- Carefully place the scarifier on an even and hard surface. Make sure that the blades don't get damaged.
- Remove the spanner from the bottom right of the handlebar.

- Slightly loosen the outer nut on the left and right front wheel to release the depth control.
- Place a level object of approx. 4 mm thick under both front wheels.
The supplied spanner can be used.
- Turn the blades manually until the tips are as close to the surface as possible.
- If the blades touch the surface they must be lifted by turning the 2 depth adjustment knobs (to the left and right) anti-clockwise until they are just above the surface level.
- Turn both depth adjustment knobs clockwise evenly.
- The depth setting is correct when the blades are only just above the surface.
- Check that the front side of the scarifier is horizontal; if not, depth adjustment must be carried out again.
- Carefully remove the objects from underneath both front wheels.
- Tighten the outer nut on the left and right front wheel to secure the depth setting.
- Replace the spanner in the right arm of the handlebar.

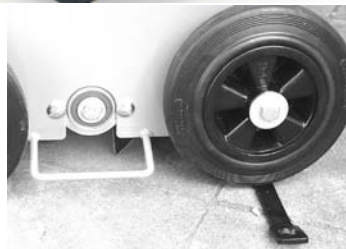

For your information:

If possibilities of front wheel depth adjustment are exhausted, the rear wheel depth setting can be used.

Using the supplied wheel spanner, remove both rear wheels. Remount the wheels, but this time in the highest bolt holes. Now the blades will touch the surface again, hence the depth setting on the front wheels must be fine-tuned. Per set of blades, the adjustment on the rear wheels can be performed only once. If a new set of blades is applied, the rear wheels must be remounted into the original bolt holes.



11.4.5 Belt tension check



Warning:

Only check the belt tension with the engine off. Remove the spark plug cap.



Warning:

Wearing gloves is mandatory.

The scarifier must be tilted to check the belt tension. The air filter must be removed prior to tilting the machine to prevent soiling it with oil. Don't tilt the machine longer than necessary; place it horizontally again as soon as possible. Should any oil seep back to the air filter compartment, remove it with a dry and totally lint-free cloth and run the scarifier without the air filter for a couple of minutes. Don't forget to replace the air filter afterwards.

- Tilt the scarifier by pushing the handlebar to the ground.
- Remove the four screws and nuts from the belt protection cover. Hold the nuts on the inside of the chassis with a second spanner when loosening the screws.
- Press the two freed belt parts towards each other. For sufficient belt tension and trouble-free operation of the blades, a one centimetre distance between them should remain when pressing the two belt parts together. No adjustment of the belt tension is required in that case. When replacing the belt protection cover, verify that it doesn't touch the pulley when the blades are engaged. The slots in the cover provide some play to avoid contact.

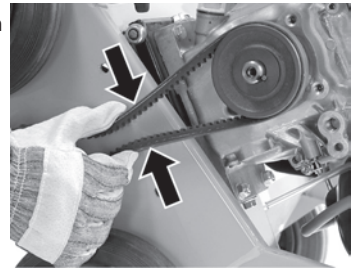
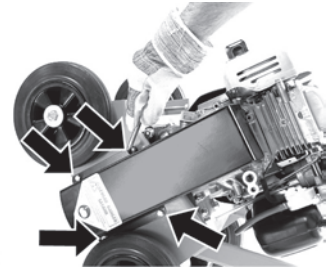

- If the belt tension proves to be too loose or too tight, it must be adjusted. A loose drive belt will bang against the protection cover (see § 11.5.5,).
- Because a new belt will expand somewhat during the first period of operation, it is recommended to adjust the tension after 10 hours of operation (for belt adjustment see § 11.5.5,).
- Reposition the scarifier on all four wheels.

11.5 Maintenance after 20 hours of operation

11.5.1 Changing the oil

- Ensure that the engine is on an even surface and turned off.
- At the rear of the engine, below the engine foot, a plug is screwed into the crankcase. (See the engine manual.)
- Get a one litre collection reservoir before unscrewing the plug.
- Empty the full contents (approx. 0.75 l) from the engine.
- Replace the plug. Wipe away any spilled oil with a clean cloth.
- Refill the engine with fresh 4 stroke oil. ELIET recommends a top quality high-detergent oil: SUNOCO DENALUBE SAE 20W50 API SF / CC.
- Fill approx. 0.75 litres of oil into the oil filler opening. Remove any spilled oil after filling. For an accurate dipstick reading of the oil level, allow sufficient time for the oil to settle in the crankcase.
- Place the dipstick in the filler opening without fastening it. After pulling it out again, the oil attached to the dipstick should reach the maximum mark. If not, more oil must be added.



Warning:

Oil shortage causes severe engine damage.



Caution:

The action described here may slightly differ from what applies to your model. Read the engine manual to be sure.

11.5.2 Checking and/or changing the spark plug

ELIET suggests the following spark plugs:

Briggs & Stratton - 6.5 hp	CV8 Champion
Honda GC 160 - 5 hp	BPR 6 ES NGK
Honda GX 160 - 6.5 hp	BPR 6 ES NGK

- Turn off the engine and pull the cable from the spark plug.
- Clean the area around the spark plug and remove the spark plug from the cylinder head.
- Using a feeler gauge, check whether the distance between electrodes is 0.8 mm.
- The spark plug must be replaced if it shows heavy deposits



or is very dirty.

- Take the following steps to verify ignition quality:
 1. Put the spark plug cap back on.
 2. Grab the rubber of the spark plug cap and press the outermost electrode against the mass of the engine.
 3. Pull the starter cord.
 4. Check for sparks between the electrodes.
 5. The spark plug is in good condition if the sparks are clear and neatly centred between the electrodes.
 6. Weak, irregular and not well-centred sparks indicate that the spark plug must be changed.



Caution:

Fitting or changing a spark plug must be done with utmost caution so as not to damage the screw thread in the cylinder head. Secure the spark plug with a torque of 20 Nm.

11.5.3 Changing the air filter

This procedure is exactly the same as for cleaning the air filter (see § 11.4.3,).

- New, suitable air filters are available from your Eliet dealer or an authorised service centre of the relevant engine brand.

11.5.4 General lubrication treatment

ELIET is committed to using high-quality materials that extend the machine's life cycle despite sometimes dusty work circumstances.

For this reason, special lubrication products have already been applied in the factory. ELIET also recommends lubricating all parts on a regular basis:

- Bearings
- Hinges

A. Lubricating bearings



Caution:

Just like for all maintenance works, the engine must be turned off.
Detach the spark plug cap or lead.
Wearing utility gloves is essential.

Bearings that are used under dusty circumstances benefit from regular cleaning and lubrication.

- Tilt the machine backwards by pushing the handlebar down. It provides easy access to the blade axle.



Caution:

Tilting the machine can lead to petrol seepage from the tank.

Prior to lubricating the bearings they must be cleared from old lubricant and deposits. Cleaning spray aimed at the bearings and in the bearing joints will do the job easily. ELIET recommends NOVATIO KLEENSPRAY-S.

- Allow it to work for a few minutes so that it can enter the bearing as well.
- Let the bearings run while blowing away all deposits and cleaning agent with compressed air. Repeat the above procedure if not all dirt was removed.
- Check that the bearing does not show excessive play. Also check that the bearing runs smoothly. In the event of defects, consult your ELIET dealer for a bearing replacement in order to avoid future inconvenience.
- Re-apply a high quality lubricant. Spray NOVATIO NOVA PTFE OIL into the joints of the bearing seal.
- Wipe away any excessive lubricant.
- Reposition the scarifier on all four wheels.

B. Lubricating hinges

To avoid wear of hinging parts or friction zones, apply lubricant regularly.

Pay special attention to the following areas:

- The tilting point of the engine's fixing plate
- Attachment points of the starter cord
- Hinge of the blade clutch handle

Follow this procedure:

- First spray the friction zones with cleaner. Allow it to sit for a while. ELIET recommends NOVATIO KLEENSPRAY-S.
- Wipe away old lubricant with a cloth or paper tissue.
- Once the friction zones are clean, new lubricant can be applied to the contact areas. We recommend NOVATIO PTFE OIL or SUNOCO MULTIPURPOSE LR - EP2. All lubricants indicated are available from your ELIET dealer.

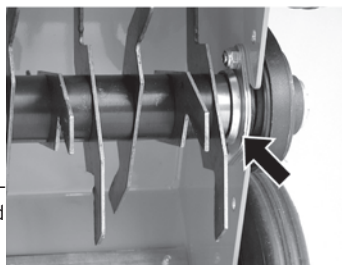

11.5.5 Belt tension adjustment

CORRECT TENSION + CORRECT ALIGNMENT

=> LONG LIFE CYCLE OF THE BELT



Caution:

When adjusting the belt tension the engine must be turned off and either the spark plug cap removed or the plug disconnected at all times.

Wearing gloves is mandatory whenever contact with the blades could occur.

- Tilt the scarifier by pushing the handlebar to the ground.
- Remove the four screws and nuts (M6) from the belt protection cover. Hold the nuts on the inside of the chassis with another spanner (10) when loosening the screws.
- Check that the operation handle is released.
- Press the two free belt parts towards each other. If when squeezed together, the distance between them is considerably less than 1 centimetre, the belt tension will be insufficient in tightened condition and will have to be adjusted.
- Loosen both lock nuts. (M10)
- Reposition the scarifier on all four wheels.
- Tighten the two bolts (M10) under the engine plate evenly until the two free belt parts can be pressed together to up to 1 cm from each other in relaxed condition.
- Check the alignment of the two brake disks. The brake disks are aligned if a slat, held against the brake disks, touches the four indicated points.
- If necessary, alignment can be adjusted via the nuts under the engine plate. The result must be that the engine plate is level with the chassis. Make sure not to disturb the belt tension in the process.

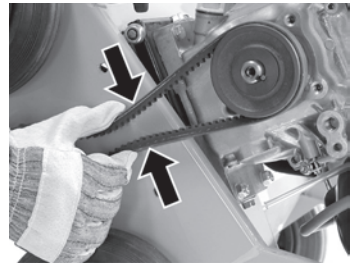
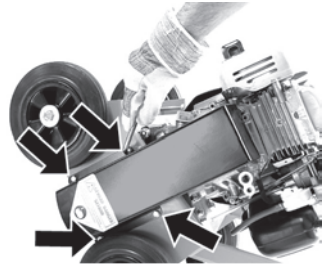

Tilt the scarifier by pushing the handlebar to the ground.

- Tighten both lock nuts (M10) under the machine.
- Place the belt protection cover. When replacing the belt protection cover, verify that it doesn't touch the pulley when the blades are engaged. The slots in the cover provide some play to avoid contact.
- Reposition the scarifier on all four wheels.

11.5.6 Changing the blades



Warning:

Wearing gloves is mandatory!

The blades are self-sharpening; they don't require sharpening.

- Blade replacement is required when the blades are fully worn.
- We strongly recommend NOT to replace only one or just a few blades since this interferes with a uniform operation of the machine across the entire width.

11.5.6.1 Fixed blades and double-cut blades

The following 2 [sic] steps must be taken for changing the fixed and the double-cut blades.

- Removal of the blade axle.
- Removal of old and placement of new blades
- Placement of the blade axle.
- Performing checks and finishing

A. Removal of the blade axle

- Tilt the scarifier by pushing the handlebar to the ground. This provides easy access of the blade axle.
- Remove the blade drive protection cover by fully unscrewing the four fixing bolts (M6). Use a second ring spanner (10) to hold the lock nut on the inside of the chassis.
- Remove the belt from the pulley. This can only be done with the blade drive declutched.

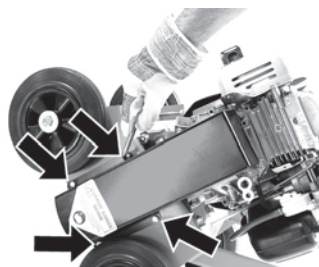

- With a ring spanner 17, loosen the centre bolt from the axle (M10). Push the pulley off the end of the axle. Now remove the wedge so as not to lose it.



Provide support for the blade axle.

- Remove the bolts (M8) that secure the two bearing holders with a ring spanner 13.
- Remove the blade axle.



For your information:

All original parts are available from your authorised Eliet dealer.

B. Changing the blades

The blades are fed on a hexagonal axle. To replace them, it suffices to remove the bearing at the pulley end.

Before sliding the bearing from the axle, slightly sandpaper the tip of the axle to remove any burrs or dirt etc. that may impair easy handling.

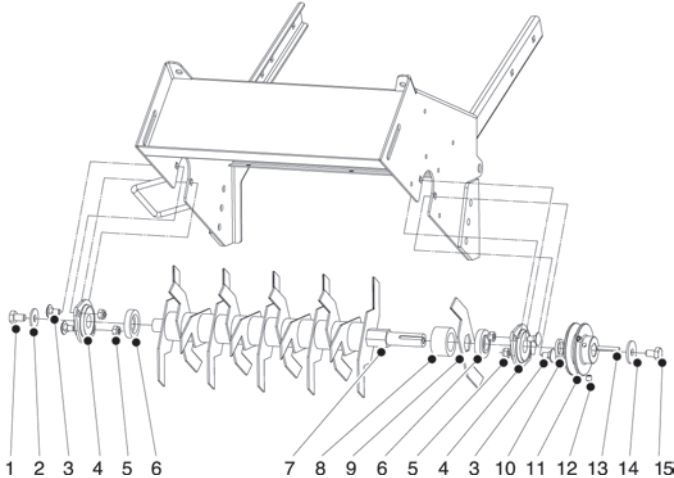

Pay special attention to the blade axle's order of assembly:

- First, remove the bearing.
- Then remove the bearing holder.



- Take the steel intermediate ring from the axle. Pay attention to how it fits on the axle.

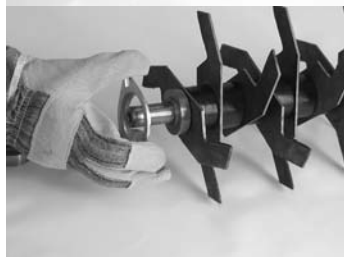

- Now slide all remaining elements from the axle, one by one.



- Clean the nylon distance collars; they will be put back in place on the axle with the new blades. The axle shows heavy wear at the location of the blades; it must be replaced as well.
- Thoroughly clean the bare axle. Use sandpaper if necessary.
- Check both bearings for signs of play. Rotating the bearings on the axle will quickly reveal any bearing noise. If there is any, replace the bearings together with the blades.
- Place the new blades on the blade axle in the correct order.
- Ensure that the blade points correspond to their spinning direction.
- Two adjacent blades are always offset at 60 degrees.



C. Placement of the blade axle

- Once the blade axle is reassembled it can be replaced into the chassis. The bearing holders must be fitted on the inside of the chassis plate.
- The two bolts of each bearing holder are temporarily put in place without securing them tightly.
- Replace the pulley on the axle. Don't forget the intermediate ring and make sure to place the wedge in the axle. Ensure that the seam of the pulley is always at the tip side of the axle.
- Tighten the pulley with centre bolt M10. This simultaneously tightens the

entire axle-assembly.

- Rotate the blades a couple of times. If the axle runs freely without stopping immediately, the bearing holders can be secured tightly. If not, tick the axle tips with a plastic hammer while the axle rotates. Once the axle rotates freely, the bearing holders can be fastened.
- Replace the belt on the pulley.

D. Performing checks and finishing

- Check the depth setting and set it correctly (see § 11.4.4). Verify that the rear wheels are mounted in the centre bolt holes. After all: the wheels were mounted in the uppermost bolt holes to use up the blades.
- Check the belt tension and set it correctly (see § 11.5.5).
- Replace the belt protection cover.
- Reposition the scarifier on all four wheels.

11.5.6.1 Loose blades

The procedure for changing the loose blades is as follows.

- Place the scarifier on its side, the air filter up.
- Remove the blades one by one by detaching the blade bolt.
- Change the blades.
- Reposition the machine on all four wheels.

12. Storing the machine



Clean the machine (see § 9.7.1).

When storing the machine for an extended period, it is recommended to follow the steps below:

- Carry out a major overhaul (see § 11.5).
- Check all nuts and bolts and fasten them where necessary. Most bolts require the use of two spanners of 10, 13 or 17 mm.
- Empty the fuel tank by running the engine until the machine runs out of fuel, or by using a siphon to pump the petrol into a jerry can (see § 9.2).
- Detach the spark plug (see § 11.5.2). Spray a little amount of penetrating oil with MoS₂ into the cylinder. Pull the starter cord until the piston is in its uppermost position. Replace the spark plug.
- To avoid rust on the machine touch up all chipped areas or treat them with anti-rust grease. Original paints/enamels in the appropriate colours are available from your ELIET dealer.
- Store the machine in a cool, dry storage area, away from possible rain. If necessary, cover it with canvas.
- Always allow the machine to cool down before storage.
- If the machine is stored outdoors, it must be properly covered with canvas. Avoid direct precipitation on the machine. ELIET highly recommends a sheltered storage place.

13. Equipment specifications



Engine selection	5.0 hp Honda GC160
.....	5.5 hp Honda GX160
.....	6.5 hp B&S Vanguard
Handlebar	Floating
Blade selection:	25 mm
.....	Fixed blades (number/thickness)
.....	18 / 3 mm
Loose blades (number/thickness)	34 / 2.5 mm
Double Cut blades (number/thickness)	31 / 1.5 mm
Depth setting	front: continuous (stepless)
.....	rear: 2 positions
Permanently Sharp Blades™	Yes
Blade clutch	Vertical belt tension
Chassis	Steel plate 3 mm
Transmission	V-belt XPA800
Operating width	500 mm
Dimensions (LxWxH in mm)	1200x740x1000 mm
Weight	63 kg

14. EC Declaration of Conformity



Machine: ELIET E501

Model number: MA 008 010 202
MA 008 020 118
MA 008 020 205
MA 008 030 118
MA 008 030 205
MA 008 040 118
MA 008 040 205

This machine has been designed and manufactured in accordance with the following European standards:

- PrEN 13684 Garden equipment - Pedestrian controlled lawn aerators and scarifiers - Safety
- DIN 33402 : Body measures

The ELIET machine factory hereby declares that after performing a hazard analysis, it is fully aware of the potential hazards and risks associated with the machine. Based upon this knowledge, the necessary steps have been taken in line with Machine Directive 89/392/EEC in order to ensure full operator safety at correct use of the machine.

Measured sound power levels Lw(A): 94dB(A)
Guaranteed sound power level Lw(A): 95 dB(A)

Date: 01/2008

Signature:

A handwritten signature in black ink, appearing to read 'Frederic LIETAER', written over a horizontal line.

Frederic LIETAER
Managing Director ELIET EUROPE NV

ELIET EUROPE NV
Diesveldstraat 2
BE - 8553 Otegem Belgium

Ph. +32 56 77 70 88 - Fax +32 56 77 52 13
info@eliet.eu - www.eliet.eu

15. Warranty conditions

Dear Customer,

We thank you for purchasing an ELIET product. Congratulations on your purchase of this machine which is sure to exceed your expectations and needs over the coming years. At ELIET, we do everything to ensure that our products function properly. That is why your product comes with a two-year warranty.

What is warranty?

At ELIET, we have strict quality rules on designing and manufacturing products. The purpose of these rules is to guarantee a long service life and permanent safety. That is why ELIET is happy to repair any hidden defects or faults during the whole run-in period (i.e. the warranty period) free of charge, provided the prescribed procedure is followed.

Warranty conditions

ELIET's warranty obligations for new machines are governed by the following conditions.

I. Warranty period

The warranty period starts the day the dealer delivers the machine to the customer (maximum one week after the purchase) and expires:

- for private use: after two years.
- for rental use: after twelve months or 100 hours of operation.
- for semi-professional and/or professional use: after twelve months or 100 hours of operation.

To apply for this warranty the customer must register the purchased product with ELIET and complete the registration details on the website

www.elieta.eu. If you don't have access to the Internet, please complete the attached registration card and return it to ELIET.

II. The Warranty does not apply in the following cases.

- Worn items (such as blades, bearings, belts, chains, gearwheels, tyres, bulbs, fuses, etc).
- Defects caused by improper use, neglect or consequential damage by an external source (fall, chippings, foreign objects, accident).
- Defects caused by improper maintenance of the machine, hence contrary to the prescribed periodic maintenance.
- Defects caused by improper repairs carried out by others than authorised ELIET dealers or after using other than original ELIET replacement parts.
- Defects caused by making improper changes to the original design of the machine.
- Faults occurring as a result of machine use contrary to the instructions contained in this manual.
- Failure to observe the prescribed warranty procedure or expiry of the warranty period.

For all problems relating to the engine, please contact an authorised service centre of the engine

manufacturer.

III. Procedure

- **Step 1 :** On the date of purchase, the customer registers his/her purchase online by completing the registration card on **www.elieta.eu**. In addition, the enclosed registration card is completed in its entirety on the day of purchase. The first part of the card has to be returned to ELIET within one month. The customer is required to keep all remaining parts of the card along with the purchase invoice for the duration of the warranty period.
- **Step 2 :** In the event of a defect becoming apparent, the customer shall have it verified by the authorised ELIET dealer. If the dealer finds a manufacturing defect, he may invoke the warranty under the terms specified.
- **Step 3 :** Every warranty application must be accompanied by a fully completed official application form. These are available to dealers from ELIET or from an ELIET importer/agent.
- **Step 4 :** The dealer orders the parts needed to perform the repairs. Next, the dealer faxes the order form together with the completed warranty form and a copy of the registration card.
- **Step 5 :** The warranty form must be stapled to the purchase invoice and sent to ELIET or an importer/agent of ELIET.
- **Step 6 :** ELIET sends the parts ordered to the dealer under the regular delivery and payment conditions.
- **Step 7 :** The defective part will be examined by ELIET's technical department prior to approving or rejecting the warranty. ELIET reserves the right to solely decide whether or not the customer has complied with the conditions applicable to the validity of this warranty, i.e. 1 year or 2 years. Faulty components automatically become the property of ELIET.
- **Step 8 :** When a warranty claim is found to be valid, ELIET will credit the warranted parts. Customers shall never be entitled to a refund of labour costs.

IV. In case of damage caused by transport

- All goods are supplied ex factory. Transport risks are borne by the customer. ELIET therefore recommends checking the goods for damage on arrival.
- Any damage found must be detailed on the delivery form before signing. Make sure the driver of the transport company puts his signature next to the details about the damage on your copy.
- In the absence of a written and signed statement on the delivery form, the transport insurance company will not accept any liability.
- Damages can be claimed from the carrier using a copy of the delivery form and a covering letter stating your complaint.
- The damaged machine should be kept in its original condition until the carrier's insurer has performed an examination.

REGISTRATIONCARD ELIET CUSTOMER SERVICE

To be able to claim the full rights to which you are entitled, it is important to register within a month after the date of purchase. Therefore, fill out this registration form and return the first registration card to the ELIET Customer Service. Your purchase should be registered on the ELIET website www.eliel.be.

REGISTRATIEKAART ELIET KLANTENDIENST

Om als klant, aanspraak te kunnen maken op waasborg dient men zich binnen de maand na aankoop bij ELIET te registreren. Hiervoor vult u onderstaand document volledig in en stuurt het eerste deel van deze registratiekaart naar de ELIET Klantendienst terug. Registratie van aankoop op de ELIET website www.eliel.be.

CARTE SERVICE

Pour profiter de tous les avantages auxquels vous êtes éligible, il est important de vous inscrire dans le mois suivant l'achat de votre produit. Complétez donc ce formulaire et renvoyez la première partie au Service Clientèle ELIET. Votre achat doit être enregistré sur le site Internet ELIET www.eliel.be.



Registratiekaart naar ELIET Klantendienst terug. Registreren Sie Ihre Kauf ebenfalls auf der ELIET Website unter www.eliel.be.

Customer Identity / Klantgegevens / Données du Client / Kundendaten

Name / Naam / Nom / Name		First Name / Voornaam / Prénom / Vorname	
Street / Straat / Rue / Strasse		Nr / N° / N° / Nr	
City code / Code Postal / Postleitzahl		City / Plaats / Ville / Stadt	
Telephone / Telefoon / Téléphone / Telefoon-Nr.		Fax / Faks / Télécoeur / Fax	
E-mail		Country / Land / Pays / Land	
		Box / Bus / Bille / Aq.	

Machine Identity / Machinegegevens / Données de machine / Daten Maschine

Model / Model / Modèle / Modell		Year of manufacture / Boekjaar / L'année de construction / Baujahr	
Article Code / Artikel code / Code d'article / Artikel-Nr.		Serialnumber / Seriennummer / Numéro de série / Serien-Nr.	
Date / Datum / Date / Datum		Signature / Handtekening / Signature / Unterschrift	
		Stamp of dealer / Stempel van handelaar / Cachet de revendeur / Stempel Fachhändler	

I declare that all information that was filled in is correct and truthful. I also declare to have read and understood the operating manual and the warranty conditions. Ik verklaar dat al deze gegevens waarheidsgetrouw werden ingevuld. Hierdoor geef ik te kennen de gebruiksaanwijzing en de garantievoorwaarden in kennis te hebben genomen en begrepen. Je déclare que tous les données complétées sont correctes et véridiques. Je déclare également d'avoir lu et compris les notices du mode d'emploi et les conditions de garantie. Ich erkläre hiermit, dass alle angegebenen Daten korrekt und wahrheitsgemäß gemacht wurden. Ich erkläre ebenso, dass ich die Garantiebedingungen gelesen und verstanden habe.

Put a crossmark to which application this machine was used

Zet een kruisje bij de toepassing waartoe deze machine wordt ingezet.

Indiquez avec une croix l'application à laquelle la machine a été utilisée.

Kreuzen Sie an, für welche Art von Gebrauch die Maschine bestimmt ist.

- Home use / Particulier gebruik / Usage particulier / Private Nutzung
- Professional Landscaping / Hoewierservice / Usage Professionnel / Gewerbliche Nutzung
- Forestry / Bosbouw / Forêt / Forstbetrieb
- Public Groundcare / Openbare groenvoorziening / Espaces Verts Public / Öffentliche Grünflächensversorgung
- Rental / Verhuur / Location / Vermietung

Dit document dient binnen de maand na aankoop teruggestuurd te worden naar de ELIET Klantendienst.

This document has to be returned to ELIET Customer Service within a month after purchase.

Remoyvez ce document au Service après-vente ELIET dans le mois suivant à la date d'achat.

Dieses Dokument muss innerhalb eines Monats nach Kaufdatum an den ELIET Kundendienst zurückgeschickt werden.

